

English



Fujitsu Server BS2000 SE Series

Additive Components

Operating Manual

Valid for:
M2000 V6.5A
X2000 V6.5A
HNC V6.5A

Edition December 2023

Comments... Suggestions... Corrections...

The User Documentation Department would like to know your opinion on this manual. Your feedback helps us to optimize our documentation to suit your individual needs.

Feel free to send us your comments by e-mail to: bs2000services@fujitsu.com.

Certified documentation according to DIN EN ISO 9001:2015

To ensure a consistently high quality standard and user-friendliness, this documentation was created to meet the regulations of a quality management system which complies with the requirements of the standard DIN EN ISO 9001:2015.

Copyright and Trademarks

Copyright © 2023 Fujitsu Technology Solutions GmbH.

All rights reserved.

Delivery subject to availability; right of technical modifications reserved.

All hardware and software names used are trademarks of their respective manufacturers.

The Xen® mark is a trademark of Citrix Systems, Inc., which manages the mark on behalf of the Xen open source community. The Xen® mark is registered with the U.S. Patent and Trademark Office, and may also be registered in other countries.

Novell and SUSE are registered brands of Novell, Inc. in the USA and other countries.

Linux is a registered brand of Linus Torvalds.

Windows® is a registered trademark of Microsoft Corporation.

The Linux-based basic software M2000, X2000, and HNC which is installed on the Management Unit, Server Unit x86, and HNC contains Open Source Software. The licenses for this can be found in the LICENSES directory on the relevant installation DVD.

Table of Contents

- Additive Components** 4
- 1 Introduction** 5
- 2 Application Unit** 6
 - 2.1 Application Unit PY (SE AU PY)** 8
 - 2.1.1 Application Unit AU25 9
 - 2.1.2 Application Unit AU47 10
 - 2.1.2.1 Front of the Application Unit 11
 - 2.1.2.2 Rear of the Application Unit 19
 - 2.2 Application Unit PQ (SE AU PQ)** 23
 - 2.3 Switching an Application Unit on/off** 24
 - 2.4 Operating system and other software** 25
 - 2.5 System operation** 26
- 3 Periphery** 27
 - 3.1 ETERNUS DX100 S4 and S5 disk storage system** 28
 - 3.2 ETERNUS LT140 and LT140-42U tape library** 29
- 4 Related publications** 30

1 Additive Components

Introduction

The Fujitsu Server BS2000 SE series with its innovative HW and SW features forms the proven mainframe line from Fujitsu. Designed as hybrid systems, the SE servers create a new quality of openness and integration capability of different server and peripheral systems with simultaneous comprehensive and cross-system manageability.

Under the umbrella of the SE infrastructure, multiple application scenarios are possible in various combinations for both mainframe applications and applications of the open world. The server architecture offers comprehensive performance scalability (scale-up and scale-out), and ensures that users can manage their application workloads securely, quickly and efficiently across technological boundaries with maximum availability.

One major aim of the SE servers is to provide a uniform management strategy which offers customers significant added value through maximum integration, and guarantees extremely cost-effective operation of their IT. The heart of the SE series is formed by the /390-based Server Units, the x86-based Server Units, the Net Unit (NU) and the Management Unit (MU).

All components are integrated into a standard 19" rack and are supplied to customers ready to use.

In addition to their high system performance, the servers of the SE series offer enhanced configuration options, maximum availability and, not least of all, significantly reduced power consumption compared with predecessors.

Depending on requirements, the SE server contains all the system components needed for operation as an overall application:

- Server Unit /390 for BS2000 guest systems
- Server Unit x86 for BS2000 guest systems
- Application Units x86 for operating Native or hypervisor systems (e.g. Linux, Windows, VMware, etc.)
- Net Unit as a high-speed, server-internal infrastructure to connect the components with each other and with the customer's IP networks.
- Shareable tape and disk periphery
- Infrastructure to connect the components with the customer's FC networks

Information on using the manual

The Operating Manual consists of a number of modules and describes the features and hardware components of the Fujitsu Server BS2000 SE series. Users should read the operating manuals carefully in order to obtain optimal performance from the SE server.

This manual describes the optional hardware components such as Application Units and peripheral devices, thus complementing the Basic Operating Manual [1]. You will find a comprehensive introductory chapter in the Basic Operating Manual. The chapters "Important notes" chapter on SE server operation and "Environmental protection and service" are contained only in the Basic Operating Manual.

In the following, abbreviations are used to describe the SE server models and their components. These are explained in the introduction to the Basic Operating Manual [1] in the section "Models, Names, Abbreviations".

Application Unit

In addition to the Server Unit, up to 256 autonomous high-end x86 servers, which are known as Application Units, can also be installed and operated in the racks of an SE server.

Application Units are particularly suitable for important corporate applications. They offer a high degree of data security and availability through highly-developed hardware and software components. Their structure (one to eight Intel processors of the XEON family) and their scalability enable them to be employed for a large number of customer applications, e.g. for medium-sized or large databases, for ERP systems and for subapplications which interwork with a BS2000 application on the Server Unit.

Several operating systems can be run on an Application Unit and there is a wide range of configurable components. The operating systems and the customer applications on the Application Unit run independently of the Server Unit.

For example, the following operating systems and hypervisor systems (for virtualization) can be used on Application Units:

- SUSE Linux Enterprise Server 12 and 15
- Red Hat Enterprise Linux 7 and 8
- VMware vSphere® ESXi 7.0 and 8.0

The list of currently supported operating systems and hypervisor systems can be found in the Release Notice for M2000 available on the manual server (<http://bs2manuals.ts.fujitsu.com>). The use of operating systems or hypervisor systems depends on the series and model of the application unit. For further details or if you want to use other operating systems or virtualization techniques, please contact the Customer Support.

It is the responsibility of the customer to configure the Application Units, and also to install and operate his/her own software on the Application Units, see the "Operation and Administration" manual [5].

Application Units are integrated into the service concept of the SE server, e.g. into remote service via the MU and into administration with the SE Manager. The following functions are offered for Application Units in the SE Manager:

- Status display of the Application Unit
- Display and configuration of the links to the web interfaces of the applications on the Application Unit
- Operation of the Application Unit and the AU VMs
- Remote powering on of the Application Units using the iRMC
- Integration into AIS Connect (remote service)
- Storage Management functions via the add-on pack StorMan

Detailed information on this subject is provided in the "Operation and Administration" manual [5].

An Application Unit occupies 1 to 7 height units (HUs) in the rack, depending on the model. Up to 256 Application Units can be installed and operated in the rack or extension racks.

Depending on the hardware base, Application Units differ as follows:

- **Application Unit PY** refers to all PRIMERGY based AUs (e.g. the AU25 or AU47 hardware models).
- **Application Unit PQ** refers to all PRIMEQUEST based AUs (e.g. the AUQ38E or DBU38E hardware models).

This section covers the following topics:

- [Application Unit PY \(SE AU PY\)](#)
 - [Application Unit AU25](#)
 - [Application Unit AU47](#)
 - [Front of the Application Unit](#)
 - [Rear of the Application Unit](#)
- [Application Unit PQ \(SE AU PQ\)](#)
- [Switching an Application Unit on/off](#)
- [Operating system and other software](#)
- [System operation](#)

Application Unit PY (SE AU PY)

The Application Unit PY (SE AU PY) are based on the different models of the Fujitsu Server PRIMERGY series.

This section covers the following topics:

- [Application Unit AU25](#)
- [Application Unit AU47](#)
 - [Front of the Application Unit](#)
 - [Rear of the Application Unit](#)

Application Unit AU25

Application Units AU25 require one or two height units in the rack. They are set up on the same system unit as the PRIMERGY servers RX2530/RX2540 M<x>. Differences in the basic units exist to permit integration of the Application Units into the SE server and to enhance the SE server's redundancy features.

In the event of questions, e.g. regarding application compatibility, the information for the PRIMERGY servers RX2530/RX2540 M<x> also applies for the Application Units of the SE server.

Security functions in the BIOS setup and on the system board protect the data against manipulation. Information on the security functions is available on the Fujitsu support pages (support.ts.fujitsu.com). Search there for the product PRIMERGY RX2530/RX2540 M<x>, choose an operating system and look under Downloads -> Documents and under Product Security.

i The following AU25 variants are supported: AU25 M4 on the basis of PRIMERGY RX2530 M4, AU25 M5 on the basis of PRIMERGY RX2540 M5, AU25 M6 on the basis of PRIMERGY RX2540 M6 as well as AU25 M7 on the basis of PRIMERGY RX2540 M7.

Features

AU25s based on PRIMERGY RX2530 contain one or two Intel XEON processors, have a storage capacity of up to 1.5 TB and offer four PCI express slots.

AU25s based on PRIMERGY RX2540 contain one or two Intel XEON processors, have a storage capacity of up to 3 TB and offer - depending on the configuration - up to eight PCI express slots.

Detailed information on the various hardware components and interfaces of the Application Units is provided in the data sheet "Fujitsu Server BS2000 SE Series". See the product site for the relevant server at <http://www.fujitsu.com/emeia>:

- > Go to *Products -> Servers -> BS2000 Mainframes -> Fujitsu Server BS2000* and select SE710/SE730 or SE310/SE320/SE330.

Application Unit AU47

Application Units AU47 require two resp. four height units in the rack. AU47s are set up on the same system unit as the PRIMERGY servers RX4770 M<x> and use the same system board. Differences in the basic units exist to permit integration of the Application Units into the SE server and to enhance the SE server's redundancy features. In the event of questions, e.g. regarding application compatibility, the information for the PRIMERGY servers RX4770 M<x> also applies for the Application Units of the SE server.

Security functions in the BIOS setup and on the system board protect the data against manipulation. Information on the security functions is available on the Fujitsu support pages (support.ts.fujitsu.com). Search there for the product PRIMERGY RX4770 M<x>, choose an operating system and look under Downloads -> Documents and under Product Security.

Features

Application Units AU47 contain two or four Intel XEON processors, have a storage capacity of up to 15 TB and offer up to ten PCI express slots.

Detailed information on the various hardware components and interfaces of the Application Units is provided in the data sheet "Fujitsu Server BS2000 SE Series". See the product site for the relevant server at <http://www.fujitsu.com/emeia>:

- > Go to *Products -> Servers -> BS2000 Mainframes -> Fujitsu Server BS2000* and select SE710/SE730 or SE310/SE320/SE330.

The following sections describe front and rear of the Application Unit:

- [Front of the Application Unit](#)
- [Rear of the Application Unit](#)

Front of the Application Unit

Front of the AU47 M5

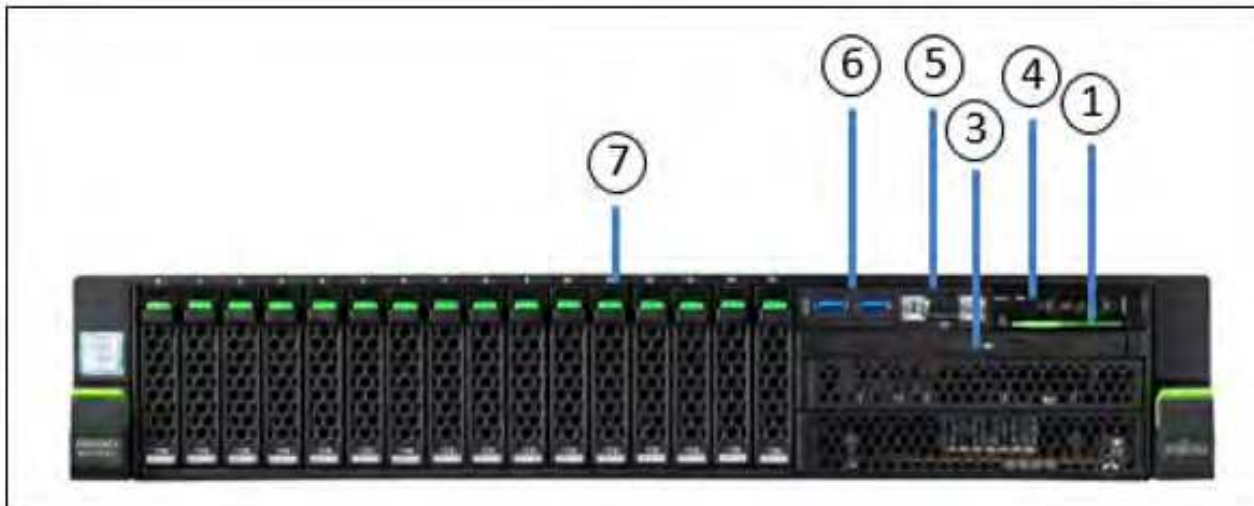

Figure 1: AU47 M5 - front

No.	Meaning
1	ID card (green)
3	Optical drive activity indicator
4	Operator control panel (for further details see figure 2)
5	Video port
6	3x resp. 2x USB ports
7	HDD indicators; 8 slots for 2.5" HDDs

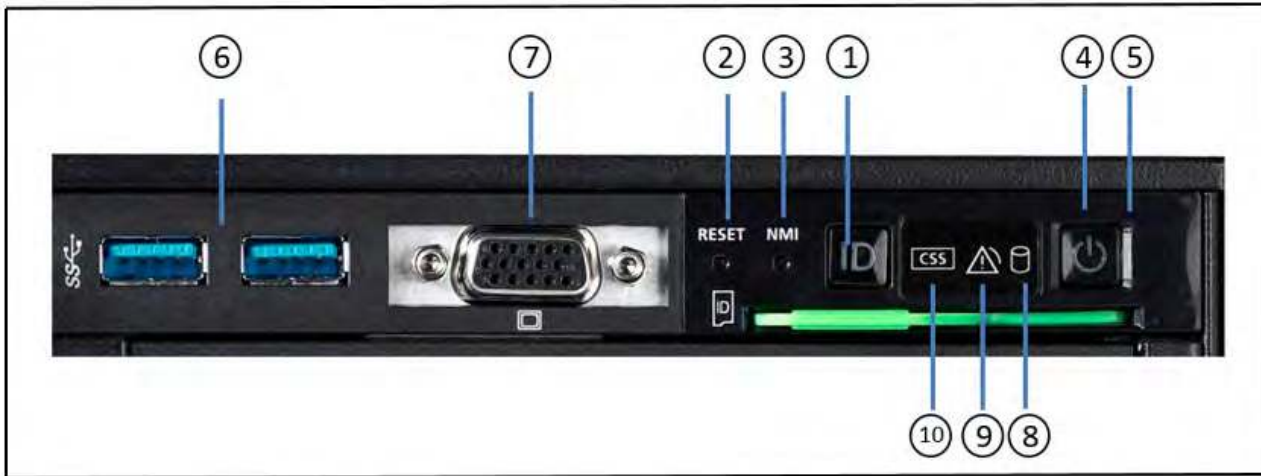

Figure 2: AU47 M5 (front) - Detailed view: operator control panel

No.	Meaning
1	ID button / ID indicator
2	Reset button
3	NMI button
4	On/Off button / Status indicator
5	Status indicator (power cable connected)
6	3x resp. 2x USB ports
7	Video port
8	HDD activity indicator
9	Global error indicator
10	CSS indicator

Front of the AU47 M6 / M7

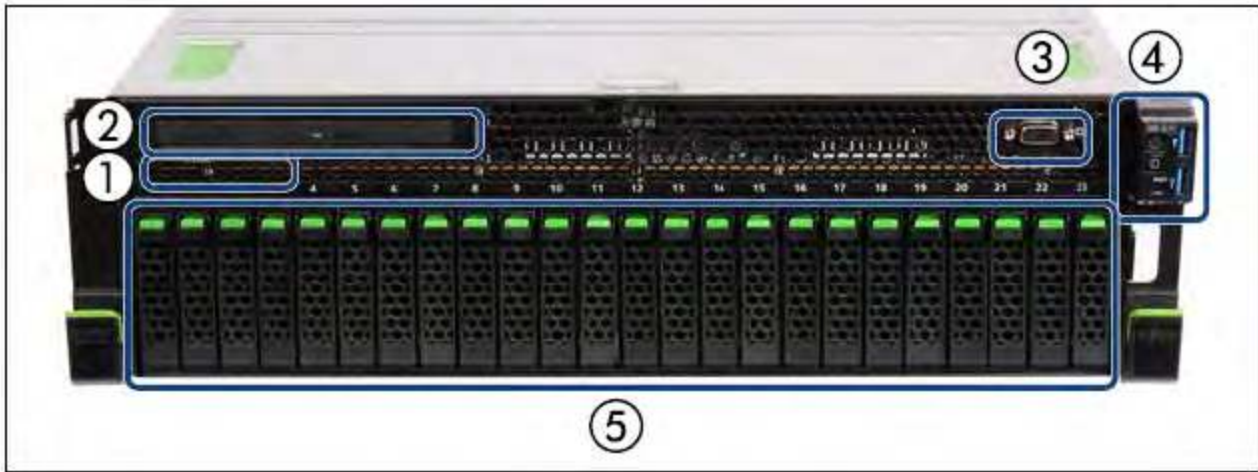

Figure 3: AU47 M6/M7 (front)

No.	Meaning
1	ID card
2	Optical disk drive (optional)
3	Video port (for Customer Support only)
4	Operating panel (for details see figure 4)
5	2.5-inch HDDs/SSDs/PCIe-SSDs (8x, 16x or 24x)

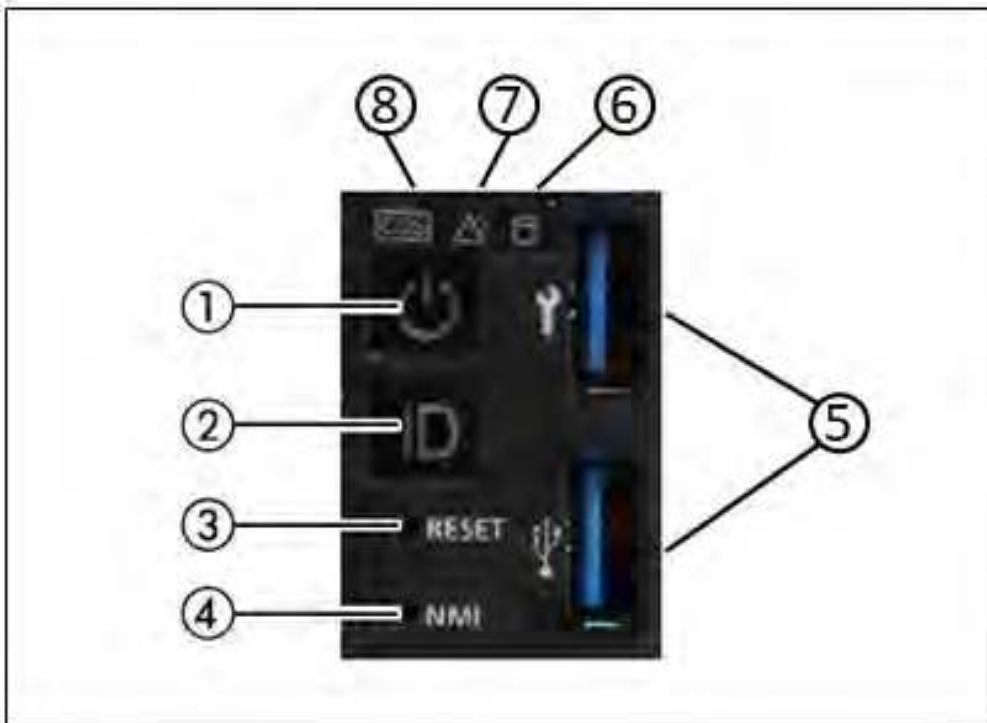

Figure 4: AU47 M6/M7 front - Detailed view: Operating panel

No.	Meaning
1	On/off switch / status indicator
2	ID button
3	Reset button
4	NMI button
5	2x USB 3.0 port
6	HDD/SSD activity indicator
7	Global error indicator
8	CSS indicator

ID card



You can pull the ID card (see [figure 1 resp. 3](#)) out and push it in again as far as it will go.

The ID card contains various system information, e.g. product name, serial number, MAC addresses and DNS name.

Controls

Control	Meaning
ID	<p>Identification (ID) button</p> <p>Lights up (blue) on the front and on the rear of the server when the ID button is pressed. The two ID indicators are synchronized.</p>
	<p>On/Off switch</p> <p>When the Application Unit is switched off, it is switched on again by pressing the On/Off switch once.</p> <p>When the Application Unit is in operation, it is switched off by pressing the On/Off switch once.</p> <div data-bbox="272 642 1455 774" style="background-color: #fff9c4; padding: 10px;"> <p>! CAUTION!</p> <p>Possible loss of data!</p> </div> <div data-bbox="272 804 1455 953" style="background-color: #e1eef6; padding: 10px;"> <p>i The On/Off switch does not disconnect the server from the voltage grid. To disconnect from the mains completely, remove the power plugs. These buttons may only be used by Customer Support.</p> </div>
RESET	<p>Reset button</p> <p>Pressing the Reset button reboots the Application Unit.</p> <div data-bbox="272 1123 1455 1255" style="background-color: #fff9c4; padding: 10px;"> <p>! CAUTION!</p> <p>Possible loss of data!</p> </div>
NMI	<p>NMI button</p> <div data-bbox="272 1367 1455 1499" style="background-color: #fff9c4; padding: 10px;"> <p>! CAUTION!</p> <p>Do not press! Possible loss of data! The NMI button may only be used by Customer Support.</p> </div>

Indicators on the operator control panel

Indicator	Meaning
ID	<p>ID indicator (blue)</p> <p>Lights up blue when the Application Unit has been selected by pressing the ID button. To deactivate, press the button again.</p> <p>The ID indicator can also be activated via the ServerView Operations Manager and the iRMC Web GUI, and the status is reported to the ServerView Operations Manager and the iRMC.</p>
	<p>Status indicator (green)</p> <p>Does not light up when the Application Unit is switched off but is connected to the power supply (power cable connected).</p> <p>Lights up green during the power up delay and in normal system operation (S0).</p> <p>Status indicator (power cable connected)(green) on the right-hand side of the On/Off switch</p> <p>Does not light up in the following cases:</p> <ul style="list-style-type: none"> • The Application Unit is not connected to the power source • The Application Unit Unit is switched on and operating normally (S0) <p>Lights up green when one of the following cases occurs:</p> <ul style="list-style-type: none"> • The Application Unit is switched off but connected to the power supply (power cable connected) • The Application Unit is switched on but is in the power up delay <div style="background-color: #e6f2ff; padding: 10px; margin-top: 10px;"> <p>i After the Application Unit has been connected to the power source, it takes approximately 60 seconds until the Application Unit has entered standby mode.</p> </div>
	<p>HDD activity indicator (green)</p> <p>Lights up green when an internal hard disk drive or a solid state drive is being accessed.</p>



Global error indicator (yellow)

Lights up yellow when a prefailure event was detected which requires Customer Support to become active (by way of precaution).

Flashes yellow when an error was detected which requires Customer Support to become active.

Does not light up when no critical event has occurred.

If the event is still acute after a power failure, the indicator is activated after the restart.

The indicator also lights up in standby mode.

You can obtain detailed information on the error cases displayed from the System Event Log (SEL), in the ServerView Operations Manager or on the web interface of the iRMC.

Indicators on the operable drives/components

Optical drive activity indicator

Lights up green when the storage medium is accessed.

! CAUTION!

If a fault occurs, please contact Customer Support.

Hard disks



Figure 5: Indicators on a hot-plug HDD module

No.	Meaning
1	HDD BUSY (green) <ul style="list-style-type: none">• Lights up: HDD in active phase (drive active, access to drive)• Does not light up: HDD inactive
2	HDD FAULT (orange) <ul style="list-style-type: none">• Does not light up: No HDD error• Lights up: HDD Faulty or Rebuild Stopped (drive defective / needs replacing, a rebuild process was stopped or the slide-in module is not correctly inserted)• Slow flashing: HDD Rebuild (the data is being restored after changing a hard disk drive)

If a hard disk drive continuously indicates an error, the drive should be replaced by Customer Support as soon as possible. In this case call Customer Support.

Rear of the Application Unit

Rear of the AU47 M5

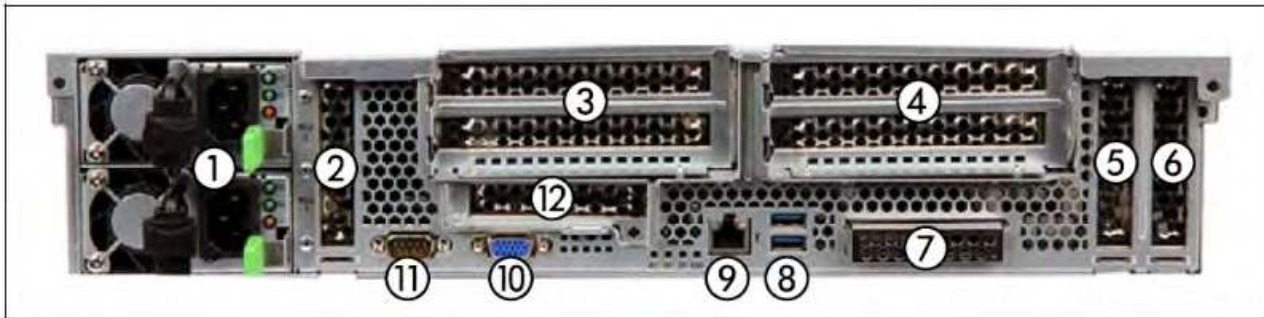

Figure 6: AU47 M5 - rear

No.	Meaning
1	Power cord connections
2	PCI slot 8 (low profile)
3	PCI slot 7 (top), PCI slot 6 (bottom)
4	PCI slot 4 (top), PCI slot 3 (bottom)
5	PCI slot 2 (low profile)
6	PCI slot 1 (low profile)
7	Onboard LAN (SYS1/SYS2 connections)
8	2x USB 3.0 ports
9	iRMC Management LAN (SYS0)
10	VGA connection (to KVM adapter)
11	Serial connection (normally unused)
12	PCI slot 5 (low profile)



Figure 7: AU47 M5 - principle of PCIe slot assignment at the rear of the device

Rear of the AU47 M6

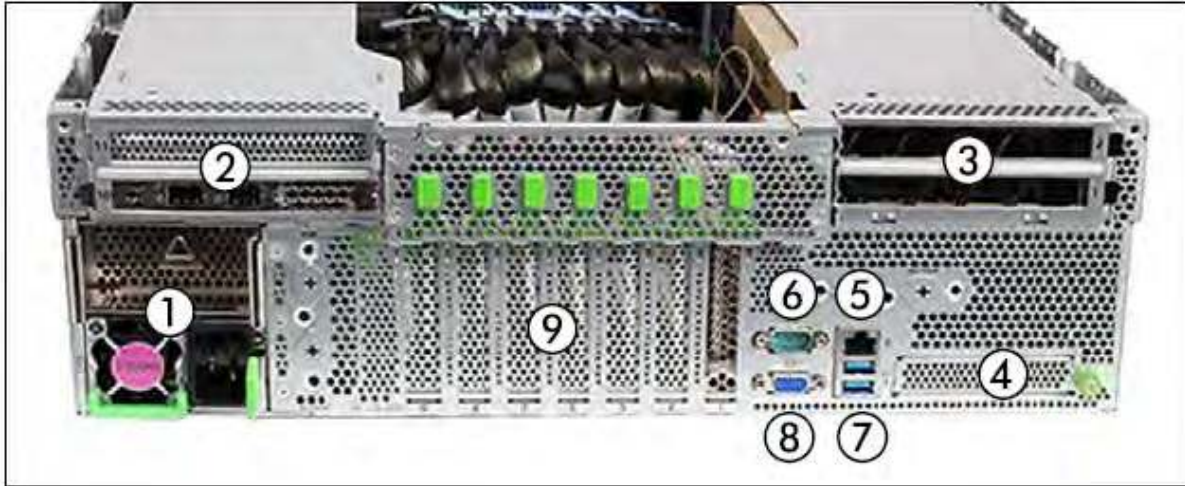

Figure 8: AU47 M6 (rear)

No.	Meaning
1	Power cord connections (one or two)
2	PCIe slots 10 and 11 (riser module)
3	PCIe slots 1 and 2 (riser module)
4	OCP module (optional)
5	Management LAN
6	Serial connection
7	2x USB 3.0 ports
8	VGA connection (to KVM adapter)
9	PCIe slots 3 - 9 (low profile)

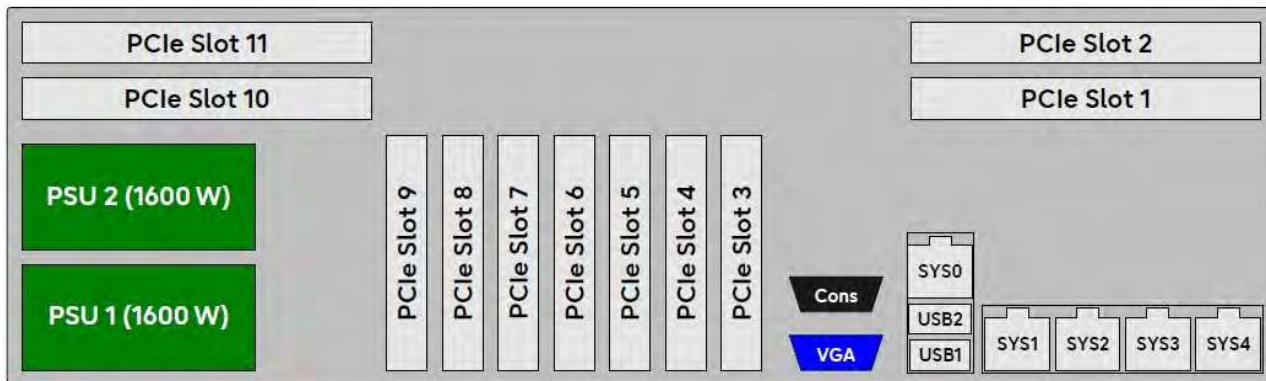

Figure 9: AU47 M6 - Principle of PCIe slot assignment at the rear of the device

Rear of the AU47 M7

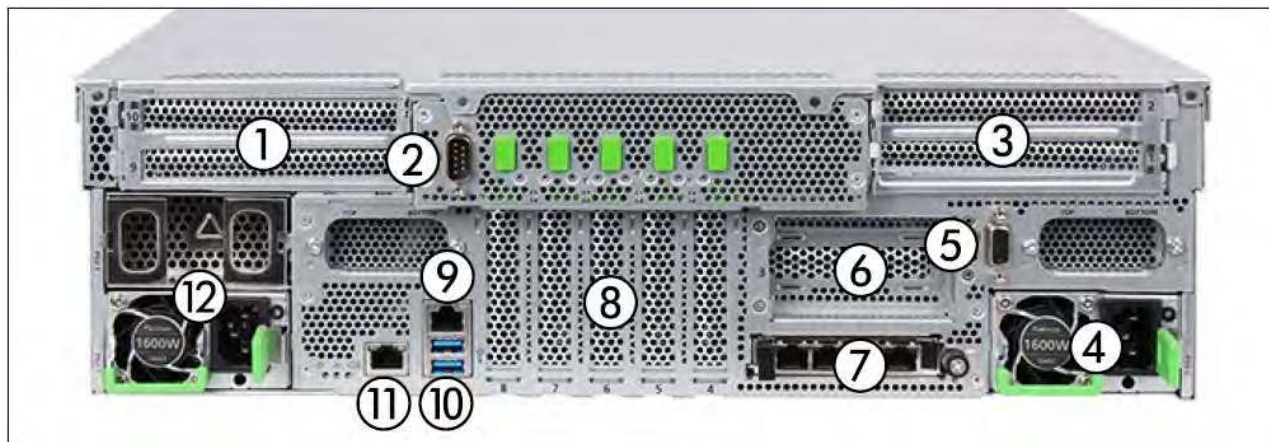

Figure 10: AU47 M7 (rear)

No.	Meaning
1	PCIe slots 9 and 10 (riser module)
2	Serial connection
3	PCIe slots 1 and 2 (riser module)
4	Power cord connection
5	VGA connection (to KVM adapter)
6	PCIe slot 3 (LP riser module, optional)
7	OCP module (optional)
8	PCIe slots 4 - 8
9	Shared LAN
10	2x USB 3.1 ports
11	Management LAN
12	Power cord connections (up to two)

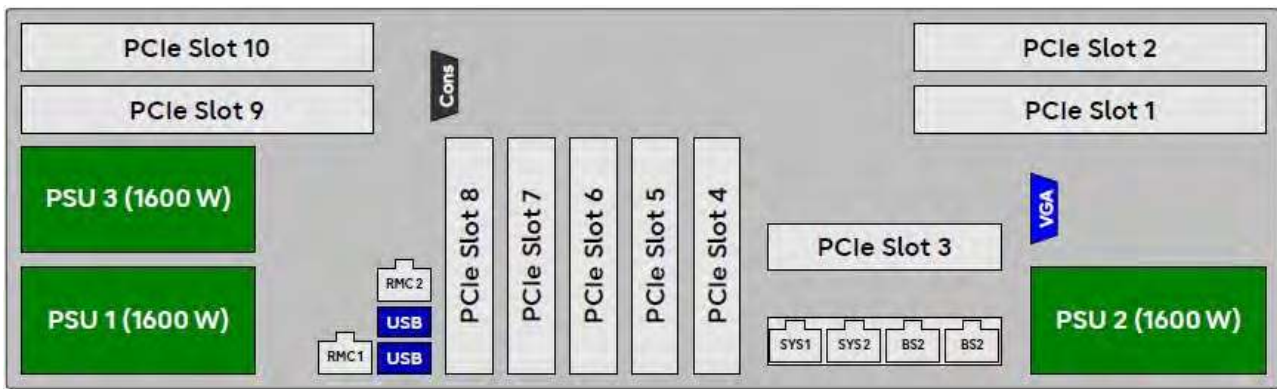

Figure 11: AU47 M7 - Principle of PCIe slot assignment at the rear of the device

Application Unit PQ (SE AU PQ)

The Application Unit PQ (SE AU PQ) is based on models of the Fujitsu Server PRIMEQUEST series, scalable with up to eight sockets of the Intel XEON processor family.

- The AUQ38E or DBU38E models are based on the PRIMEQUEST PQ3800E, which requires seven height units in the rack.

The SE AU PQ combines the economic and flexibility benefits of x86 standards with mission-critical uptime features.

Isolated partitions enable high availability, where any hardware failure does not have any impact on other partitions. Partitioning enables also flexibility in using the hardware resources, as the partitions can be configured as needed for the workload of applications.

With the SE AU PQ are two high-end usage scenarios possible:

- A general usage by customers: The customer determines the HW expansion of the AU, selects hypervisor and /or operating system(s) and is responsible for the operation itself. Monitoring and administration is carried out by the customer partly using the SE manager and partly with the tools of the software used.
- Usage as Fujitsu powered appliance: In a project-specific manner, the AU is configured by Fujitsu service employees in cooperation with the customer and the required SW configuration is defined. In the agreed framework, the required software will be installed before delivery and the AU will be administered by Fujitsu.

An example of this procedure is Oracle Database Server based on SE Application Units DBU38E (SE DBU).

The SE DBU offers an integrated, secure, mainframe-class appliance consisting of hardware and hypervisor software which can be used by the customer like an IaaS (Infrastructure as a Service): The customer is responsible for the operating system and database in the VMs on the DBU87, while Fujitsu delivers and configures everything, takes care of the licenses and maintains the hardware and hypervisor software during the whole lifecycle. Advantages for customers arise from the optimized cost efficiency, simplified operation and most current database versions on x86.

The original documentation of the PRIMEQUEST series applies for SE AU PQ. Note that some features of the PRIMEQUEST series may be released with restrictions for use on the SE server. You will find details of this in the Release Notice.

The manuals for the PRIMEQUEST series are available on the Fujitsu support pages (support.ts.fujitsu.com). Search there for the product PRIMEQUEST 3800E2, choose an operating system and look under Downloads -> Documents.

i The manuals are only available in English.

Switching an Application Unit on/off

The Application Units are switched on and off individually or together with the other components of the SE server.

Information on switching on and starting the SE server and on switching it off and shutting it down is provided in the Basic Operating Manual [1], section "Switching the server on and off".

Other On/Off options

- SE Manager
As administrator or AU administrator logged-in to the SE Manager, in the *Units* table under *Hardware -> Units* click the *Power off* icon by the desired Application Unit.
Further information can be found in the Quick Guide [7].
- iRMC
The iRMC offers various options for switching the Application Unit PY on and off, e.g. via the Power On Off page of the iRMC Web GUI.

i In the case of AU PQ, a Management Board is available instead of the iRMC. The AU can only be switched on/off at partition level.

- Timed power-on/off
You can configure a timed power-on/off on an AU PY with the help of the iRMC.
- After power failure
An Application Unit which is switched on reboots automatically following a power failure (depending on the settings in the BIOS setup or in the iRMC for AU PY resp. in the Management Board for AU PQ).
- Power Button Override
The Application Unit can be switched off by pressing and holding down the On/Off button (for approximately 4 - 5 seconds).

! **CAUTION!**
There is a risk that data may be lost!

- Wake up On LAN (WOL)
An Application Unit is switched on by a command via the LAN (Magic Packet TM).

Operating system and other software

Application Units are supplied with the software ordered and are configured by Customer Support. If you require further software, please contact the Fujitsu Services sales department.

i The customized ISO image of Fujitsu must be used for vSphere Servers. This can be downloaded via <https://support.ts.fujitsu.com>.

You will find information on how to install software and how to configure the Application Unit in the “Operation and Administration” manual [5] and in the SE Manager's online help.

System operation

Server management is implemented using the ServerView Operations Manager supplied and the PDA (Prefailure Detection and Analysis) technology from Fujitsu Technology Solutions. PDA reports the threat of a system error or overload at an early stage, allowing preventive measures to be taken.

i You can download the ServerView software from the Fujitsu support site (download via <https://support.ts.fujitsu.com>).

You will find information on how Application Units are integrated into remote service in the “Operation and Administration” manual [5] and in the SE Manager's online help.

Periphery

The following peripherals can be operated on the SE server:

- ETERNUS DX disk storage system
See <http://www.fujitsu.com/uk>:
 - > [Go to Support -> IT Products and Systems -> Storage](#).
In *Browse for Product* select product line *Storage* -> product group *ETERNUS* -> product family *ETERNUS DX*.
- ETERNUS CS tape storage virtualization system
See <http://www.fujitsu.com/uk>:
 - > [Go to Support -> IT Products and Systems -> Storage](#).
In *Browse for Product* select product line *Storage* -> product group *ETERNUS* -> product family *ETERNUS CS*.
- Scalar tape library
See <http://www.fujitsu.com/uk>:
 - > [Go to Products -> IT Products and Systems -> Servers -> BS2000 Mainframes -> Peripherals -> Tape Systems](#) and select *Scalar Series*.
- ETERNUS DX100 S4 and S5 disk storage system
See [section "ETERNUS DX100 S4 and S5 disk storage system"](#).
- ETERNUS LT140 and LT140-42U tape library
See [section "ETERNUS LT140 and LT140-42U tape library"](#).

This section covers the following topics:

- [ETERNUS DX100 S4 and S5 disk storage system](#)
- [ETERNUS LT140 and LT140-42U tape library](#)

ETERNUS DX100 S4 and S5 disk storage system

The scalable and unified Fujitsu Storage ETERNUS DX100 S4 resp. S5 delivers enterprise-class functionality to small and medium-sized companies and subsidiaries with an excellent price/performance ratio. It is the perfect solution when consolidating data for server virtualization, e-mail, databases and business applications as well as centralized file services. Simple, intuitive system management, highly flexible connectivity, granular scalability and the option to upgrade to a higher system significantly reduce operational and migration costs. The ETERNUS DX family architecture lets customers benefit from software options, such as thin provisioning, automatic storage tiering, transparent failover and quality of service management even as early as the entry-level class. This all contributes to better business support and guarantees continuity and efficiency in daily operations.



Figure 12: ETERNUS DX100 S4

For further information on DX100 S4 and S5, please refer to the original documentation, e.g. <https://www.fujitsu.com/emeia/products/computing/storage/disk/eternus-dx/dx100-s5/>.

ETERNUS LT140 and LT140-42U tape library

The Fujitsu Storage ETERNUS LT140 is a cost-effective tape library providing extreme expansion flexibility up to 8400 TB. Starts with a 3U base unit and 20 slots while the pay-as-you-grow concept provides high investment protection that enables to scale and address long-term data storage requirements. Highly automated, simple and remote operation allows ease of use even at remote sites. The standardized LTO technology features high capacity, high speed and low cost that provide hardware-based data encryption offering enhanced security and compliance.

The LT140 tape library occupies three height units in the rack. Available are LTO drives with Fibre Channel connection of the generation LTO-6, LTO-7 and LTO-8 (depending on availability). For the drives, LTO-(n) drives are read and write compatible with drives LTO-(n-1) and read compatible with LTO-(n-2) (the latter only for n=6, 7). Only one drive and only Fibre Channel direct connection are supported.



Figure 13: ETERNUS LT140

For further information on LT140, please refer to the original documentation, e.g. <https://www.fujitsu.com/emeia/products/computing/storage/tape/eternus-lt/lt140/>.

Only on SU330 / SU330B the extended model ETERNUS LT140-42U is additionally supported.

Related publications

You can find the following BS2000 manuals on the manual server with the BS2000 documentation at <http://bs2manuals.ts.fujitsu.com>.

Other manuals, for example descriptions of the FUJITSU PRIMERGY and PRIMEQUEST servers, can be found on the general Fujitsu manual server at <http://manuals.ts.fujitsu.com>.

- [1] **Fujitsu Server BS2000 SE Series
Basic Operating Manual**
- [2] **Fujitsu Server BS2000 SE Series
Server Unit /390**
Operating Manual
- [3] **Fujitsu Server BS2000 SE Series
Server Unit x86**
Operating Manual
- [4] **Fujitsu Server BS2000 SE Series
Additive Components**
Operating Manual
- [5] **Fujitsu Server BS2000 SE Series
Operation and Administration**
User Guide
- [6] **Fujitsu Server BS2000 SE Series
Security Manual**
User Guide
- [7] **Fujitsu Server BS2000 SE Series
Quick Guide**
User Guide