

English



Fujitsu Server BS2000 SE Series

Basic Operating Manual

Valid for:
M2000 V6.5A
X2000 V6.5A
HNC V6.5A

Edition December 2023

Comments... Suggestions... Corrections...

The User Documentation Department would like to know your opinion on this manual. Your feedback helps us to optimize our documentation to suit your individual needs.

Feel free to send us your comments by e-mail to: bs2000services@fujitsu.com.

Certified documentation according to DIN EN ISO 9001:2015

To ensure a consistently high quality standard and user-friendliness, this documentation was created to meet the regulations of a quality management system which complies with the requirements of the standard DIN EN ISO 9001:2015.

Copyright and Trademarks

Copyright © 2023 Fujitsu Technology Solutions GmbH.

All rights reserved.

Delivery subject to availability; right of technical modifications reserved.

All hardware and software names used are trademarks of their respective manufacturers.

The Xen® mark is a trademark of Citrix Systems, Inc., which manages the mark on behalf of the Xen open source community. The Xen® mark is registered with the U.S. Patent and Trademark Office, and may also be registered in other countries.

Novell and SUSE are registered brands of Novell, Inc. in the USA and other countries.

Linux is a registered brand of Linus Torvalds.

Windows® is a registered trademark of Microsoft Corporation.

The Linux-based basic software M2000, X2000, and HNC which is installed on the Management Unit, Server Unit x86, and HNC contains Open Source Software. The licenses for this can be found in the LICENSES directory on the relevant installation DVD.

Table of Contents

- Basic Operating Manual** 5
- 1 Introduction** 6
 - 1.1 Models, Names, Abbreviations** 8
 - 1.2 Documentation for the SE servers** 10
 - 1.3 Objective and target groups of this manual** 11
 - 1.4 Summary of contents** 12
 - 1.5 Changes to the predecessor manual** 13
 - 1.6 Notational conventions** 14
- 2 Important notes** 15
 - 2.1 Notes from the manufacturer** 16
 - 2.2 Notes on safety** 17
 - 2.3 Installation and operation precautions** 19
- 3 System overview and features** 21
 - 3.1 Rack of the SE server** 23
 - 3.2 Expanded maintenance and operational functions** 25
- 4 Racks** 26
 - 4.1 Basic rack** 27
 - 4.2 Extension rack** 28
 - 4.3 Power supply** 29
- 5 Controls** 31
 - 5.1 Rack console** 32
 - 5.2 Console switch** 40
 - 5.3 Control panel (on the SE /390)** 41
 - 5.3.1 Function of the displays 42
 - 5.3.2 Function of the keys and switches 44
- 6 Management Unit** 45
 - 6.1 Front of the MU** 46
 - 6.1.1 Controls 50
 - 6.2 Rear of the MU** 53
- 7 Net Unit** 58
 - 7.1 Switches** 59
 - 7.1.1 Brocade switches 60
 - 7.1.2 Juniper switches 61
 - 7.2 Extension of the Net Unit** 63
- 8 Switching the server on and off** 64
 - 8.1 Switching the SE x86 on and off** 65
 - 8.1.1 Switching off in an emergency 66

8.1.2 Switching the SE server on 67

8.1.3 Switching the SE server off 69

8.2 Switching the SE /390 on and off 71

8.2.1 Switching off in an emergency 72

8.2.2 Switching the SE server on 73

8.2.3 Switching the SE server off 76

9 Environmental protection and service 78

10 Abbreviations 80

11 Related publications 81

Basic Operating Manual

1 Introduction

The Fujitsu Server BS2000 SE series with its innovative HW and SW features forms the proven mainframe line from Fujitsu. Designed as hybrid systems, the SE servers create a new quality of openness and integration capability of different server and peripheral systems with simultaneous comprehensive and cross-system manageability.

Under the umbrella of the SE infrastructure, multiple application scenarios are possible in various combinations for both mainframe applications and applications of the open world. The server architecture offers comprehensive performance scalability (scale-up and scale-out), and ensures that users can manage their application workloads securely, quickly and efficiently across technological boundaries with maximum availability.

One major aim of the SE servers is to provide a uniform management strategy which offers customers significant added value through maximum integration, and guarantees extremely cost-effective operation of their IT. The heart of the SE series is formed by the /390-based Server Units, the x86-based Server Units, the Net Unit (NU) and the Management Unit (MU).

All components are integrated into a standard 19" rack and are supplied to customers ready to use.

In addition to their high system performance, the servers of the SE series offer enhanced configuration options, maximum availability and, not least of all, reduced power consumption compared with predecessors.

Depending on requirements, the SE server contains all the system components needed for operation as an overall application:

- Server Unit /390 for BS2000 guest systems
- Server Unit x86 for BS2000 guest systems
- Application Units x86 for operating Native or hypervisor systems (e.g. Linux, Windows, VMware, etc.)
- Net Unit as a high-speed, server-internal infrastructure to connect the components with each other and with the customer's IP networks.
- Shareable tape and disk periphery
- Infrastructure to connect the components with the customer's FC networks



Figure 1: SE Server SE730

1.1 Models, Names, Abbreviations

Due to the frequent use of the names, the following **abbreviations** are used in the manuals for the SE servers:

- **SE server** for the Fujitsu Server BS2000 SE Series independent of the model
An SE server contains several components or units, but at least one Server Unit, one Management Unit and one Net Unit.
Depending on the built-in unit types and models, the following server models are distinguished:
 - **SE710** for Fujitsu Server BS2000 SE710
(with SU710, AUs optional)
 - **SE730 / SE730B** for Fujitsu Server BS2000 SE730 / SE730B
(with SU730 / SU730B, SU330 / SU330B and AUs optional)
 - **SE310** for Fujitsu Server BS2000 SE310
(with SU310, AUs optional)
 - **SE320** for Fujitsu Server BS2000 SE320
(with SU320, AUs optional)
 - **SE330 / SE330B** for Fujitsu Server BS2000 SE330 / SE330B
(with SU330 / SU330B, AUs optional)

- **Server lines**
The above server models are combined into two server lines:
 - **SE /390** for Fujitsu Server BS2000 SE710 / SE730 / SE730B, i.e. for SE servers with an SU /390
 - **SE x86** for Fujitsu Server BS2000 SE310 / SE320 / SE330 / SE330B, i.e. for SE servers with SU x86 only resp. without an SU /390

- **SU** for a Server Unit independent of the unit type
The SU is a component of the SE server that enables the operation of BS2000 (Native-BS2000 or VM2000).
Depending on the unit type, a distinction is made between SUs:
 - **SU /390** for Server Unit /390 (type of a Server Unit with one or more /390 processors) with the models SU710 in the server SE710 and SU730 / SU730B in the server SE730 / SE730B
 - **SU x86** for Server Unit x86 (type of a Server Unit with one or more x86 processors) with the models SU310 in the server SE310, SU320 in the server SE320 and SU330 / SU330B in the server SE330 / SE330B

- **MU** for the Management Unit
The MU is the component of an SE server which enables the central web-based management of all units of the SE server.

- **AU** for the Application Unit (with x86-based hardware)
The AU is an optional component of the SE Server, which enables the operation of customer applications under Linux, Windows, VMware or other hypervisors.
Depending on the hardware base, AUs are differentiated as follows:
 - **AU PY** denominates all PRIMERGY-based AUs (e.g. the hardware models AU25 or AU47).
 - **AU PQ** denominates all PRIMEQUEST-based AUs (e.g. the hardware models AUQ38E or DBU38E).

-
- **HNC** (High-speed Net Connect)
The HNC connects the Server Unit /390 to the LAN and as a net client enables the BS2000 systems on the SU /390 to access the Net-Storage.
HNC refers to both the Linux-based basic software and the hardware unit itself on which this basic software runs.
 - **NU** (Net Unit)
The NU enables the connection of an SE server to the customer network (LAN). It contains switches and, if necessary, the HNC.
 - **Unit x86**
Component of an SE Server with x86 architecture: Server Unit x86, Management Unit or HNC
 - **BS2000 server**
BS2000 server is used as generic term for all SE servers and the former S- and SQ servers. BS2000 servers are operated with the corresponding BS2000 operating systems.
 - **BS2000**
BS2000 is used for the BS2000 OS DX operating system in phrases, e.g. in BS2000 system.
 - **SKP** (Service Konsol Processor)
The MU implements the SKP functionality required for the operation of an SU /390.
 - **SVP** (Service Processor)
Service processor of the SU /390

For a description of the further features of the SE servers, please refer to the [chapter "System overview"](#).

1.2 Documentation for the SE servers

A wide range of documentation is available for the SE servers on the manual server at <https://bs2manuals.ts.fujitsu.com>.

- The manuals on BS2000 OS DX, which provide the basic literature.
- The manuals for the system-related software products also apply.

Any additions to the manuals are described in the Readme files for the various product versions. These Readme files are also available on the manual server with the BS2000 documentation under the various products.

Current information, version and hardware dependencies and instructions for installing and using a product version are contained in the associated Release Notice. Release Notices, in particular those relating to BS2000 OS DX, M2000, X2000, and HNC, are also available on the manual server.

The documentation for the SE servers consists of the following parts:

- Operating Manual (consisting of a number of modules):
 - Basic Operating Manual
 - Operating Manual Server Unit /390
 - Operating Manual Server Unit x86
 - Operating Manual Additive Components
 - Cluster Solutions for SE Servers
- Operation and Administration
- Security Manual
- Quick Guide

Further literature is listed in [Related publications](#).

Detailed information on the various hardware components and interfaces of the SE servers is provided in the data sheet "Fujitsu Server BS2000 SE Series".

See the product site for the relevant server at <https://www.fujitsu.com/emeia/products/computing/servers/mainframe/bs2000/>:

- > Go to *Fujitsu Server BS2000* and select the desired SE server model.

1.3 Objective and target groups of this manual

The Operating Manual for the servers of the SE Series consists of a number of modules and describes the features and hardware components of the Fujitsu Servers BS2000 of the SE Series. Users should read this manual carefully in order to obtain optimal performance from the SE server.

Readers require a knowledge of BS2000 system operation and administration as well as basic knowledge of Linux. In some places knowledge of X2000 is helpful. This can be obtained from the “Operation and Administration” manual [5].

This manual is intended for people who operate an SE server:

- As administrator you manage the entire SE server with all its components and the operating systems which run on it. You need a good knowledge of the BS2000, Linux and Windows operating systems and of the network and peripherals.
As administrator you can also manage the integration of the optional Application Units on which an open operating system runs in Native or virtualized mode (e.g. under VMware).
- As BS2000 operator you operate BS2000 on the Server Unit of the SE server. You need a good knowledge of the BS2000 operating system and also of the connected peripherals.

1.4 Summary of contents

This operating manual deals with the hardware-related display and operating functions of the Fujitsu BS2000 servers of the SE Series.

The chapter "Important notes" contains important information on the installation and safe operation of the SE server and the components.

The content of the following chapters describes the components of the SE server, their position in the rack, the controls, MU and NU as well as how to switch the server on and off. There is also a chapter containing the abbreviations used and their meaning.

A glossary explaining important terms used in this manual can be found in the "Administration and Operation" manual [\[5\]](#).

References to publications are given in the text with shortened forms of the titles in quotes. The "Related publications" chapter lists the full title of each document that is referred to.

1.5 Changes to the predecessor manual

This release describes optional hardware components that are supported by the basic software M2000/X2000/HNC V6.5A or higher:

- New hardware generation SE330 / SE330B and SE730 / SE730B
- With SE330 and SE730 a new variant MU M4 of the hardware base for the Management Unit is used.
- With SE330B and SE730B a new variant MU M5 of the hardware base for the Management Unit is used.
- With SE730 a new variant HNC M4 of the hardware base for the HNC is used.
- With SE730B a new variant HNC M5 of the hardware base for the HNC is used.
- With SE330 a new variant SU330 of the hardware base for the Server Unit is used.
- With SE330B a new variant SU330B of the hardware base for the Server Unit is used.

1.6 Notational conventions

The following **notational conventions** are used in this manual:

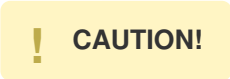
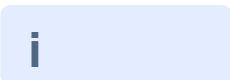
 WARNING!	This indicates a hazardous situation which <i>could result in serious personal injury</i> if the user does not perform the procedure correctly.
 CAUTION!	This indicates a hazardous situation which <i>could result in minor or moderate personal injury</i> , if the user does not perform the procedure correctly. This signal also indicates that damage to the product or other property <i>may</i> occur if the user does not perform the procedure correctly. This indicates also the tasks which are performed by Customer Support.
	This indicates information that could help the user to use the product more effectively.
>	The prompt symbol indicates activities which need to be performed (e.g. entries on the keyboard).
<i>italics</i>	Texts from the SE Manager
monospace	System inputs and outputs
monospace semibold	Statements which are entered via the keyboard are displayed in this font.
<abc>	Variables which are replaced by values.
[number]	The titles of related publications in the text are abbreviated. The complete title of each publication which is referred to by a number is listed in the Related Publications chapter after the associated number.

2 Important notes

In this chapter the following subjects are discussed:

- [Notes from the manufacturer](#)
- [Notes on safety](#)
- [Installation and operation precautions](#)

2.1 Notes from the manufacturer

The system fulfills the requirements of the EU directives 2014/30/EU "Electromagnetic Compatibility" and 2014/35/EU "Low Voltage Directive", 2009/125/EC (Ecodesign) and the directive regarding the restriction of the use of particular hazardous substances in electrical and electronic equipment 2011/65/EU. Each individual component bears the CE Marking to confirm this (CE = Communauté Européenne).

For safe operation

This manual contains important information regarding the use and handling of this product. Read this manual thoroughly. Pay special attention to the [section "Note on safety"](#) Use the product according to the instructions and information available in this manual. Keep this manual handy for further reference.

The manufacturer makes every effort to prevent users and bystanders from being injured or from suffering damage to their property. Use the product according to this manual.

About this product

The Fujitsu Server BS2000 of the SE Series is designed and manufactured for use in standard applications such as computing center work, office work, and general industrial applications. This product is not intended for use in nuclear-reactor control systems, aeronautical and space systems, air traffic control systems, mass transportation control systems, medical devices for life support, missile launch control systems or other specialized uses in which extremely high levels of reliability are required, the required levels of safety cannot be guaranteed, or a failure or operational error could be life-threatening or could cause physical injury.

i These safety-critical areas of application are hereafter referred to as "Areas of application with high safety requirements".

You may not use the product in areas with high safety requirements without ensuring the required level of safety. If you wish to use this product in an area of application with high safety requirements please consult the responsible sales representatives before use.

Trademark acknowledgments

- Linux is a free multiplatform multiuser operating system.
- Ethernet is a registered trademark of Xerox Corporation in the United States and in certain other countries.
- All other product names mentioned herein are the trademarks or registered trademarks of their respective owners.
- System and product names in this manual are not always noted with trademark (™) or registered trademark symbols (®).

2.2 Notes on safety

Note regarding radio interference suppression

! WARNING!

This is a product which meets Class A of EN55022. In a domestic environment this product may cause radio interference in which case the user may be required to take adequate measures.

Important alert messages

! CAUTION!

This alert signal indicates a hazardous situation that could result in minor or moderate personal injury if the user does not perform the procedure correctly. This signal also indicates that damage to the product or other property may occur if the user does not perform the procedure correctly.

Warning
Possible damage to the system if used incorrectly Be sure to follow the precautions below when installing the equipment. Otherwise, the business server may be damaged.
Possible damage to the system if used incorrectly In the factory all the power cables are connected to the power distribution units which are integrated into the rack. Attach the connection cables of the multiple socket outlets to the in-house installation so that they are easy to access. Do not connect any additional consumer loads to the power distribution units - this could cause the nominal load capacity of the multiple socket outlet or feed cables / fuses to be exceeded! If you want to connect additional equipment, please contact Customer Support.
Possible data loss if used incorrectly Before shutting down power, you should ensure that the following events occur; otherwise data may be destroyed. All applications have finished processing. No user is using the components. When a unit of the SE server (MU, SU, HNC or AU) is turned off, the operating status indicator lights up orange. Check this before shutting down the main power (to UPS, power cable, and power distribution box). If necessary, back up files before shutting down.

Maintenance

! WARNING!

All maintenance measures which are described in this manual may only be performed by the Customer Support. Incorrect performance of these tasks may cause electric shock, injury, or fire.

- Installation and reinstallation of all components, and initial settings
- Removal of front, rear, or side covers
- Mounting/de-mounting of optional internal devices
- Plugging or unplugging of external interface cables
- Maintenance and inspections (repairing, and regular diagnostics and maintenance)

! CAUTION!

All maintenance measures for this product and the optional products of the manufacturer may only be performed by Customer Support. Users must not perform these tasks. Incorrect operation of these tasks may cause malfunction.

2.3 Installation and operation precautions

! CAUTION!
Equipment damage

Be sure to follow the precautions below when installing or operating the equipment. Otherwise, the SE server may be damaged.

Installation precautions

! WARNING!

The SE server is installed on the vendor's premises. Modifications may only be carried out by Customer Support. The customer may not make any changes to the server!

The following section is therefore for information purposes only.

Follow the instructions below to ensure safety when positioning the SE server:

- The Server Unit, Management Unit, Application Units and further components are installed in one or more closed racks. Consequently the ambient operating temperature inside the rack may be higher than the room temperature. Install the business server in an environment in which the ambient temperature is always below 35 °C (95 °F).
 - Adjust air circulation to prevent the temperature inside the rack from exceeding the maximum ambient temperature specified for the server components.
 - The maximum allowable operating temperature of the server components is 35°C (95 °F).
- A certain amount of air flow is required for safe operation of the server components.
 - The server components have ventilation openings at the front and rear. Do not cover or close the ventilation openings. Doing so may cause the server components to overheat.
- Positioning the Business Server may cause the entire rack to be unstable because of uneven mechanical loading.
- The racks of the SE server have no stabilizer. When an SU or heavy peripherals are pulled out of the rack, there may therefore be a risk of it tipping over.
- The power supply for the server components is implemented via power distribution units mounted in the rack which themselves must be connected to the inhouse power supply using appropriate CEE connectors.
- The large number of power supply components in the rack means that the configuration can generate leakage currents > 3.5 mA.
- For this reason the rack may be connected to the in-house power network only via permanent links or industrial cables in accordance with IEC 60309 (formerly IEC 309) .

! CAUTION!
Equipment damage

In configurations with multiple feed cables such as the SE server, it must be noted that all cables must be disconnected to disconnect the system from the power network.

Operating precautions



WARNING!

Danger of electric shock and fire

- Do not damage, break or modify the cables. Cable breaks can cause electric shocks and fires.



CAUTION!

Equipment damage

- Do not cover or block ventilation openings.
- Install the SE server in a location away from direct sunlight and sources of heat.
- Install the Server Unit in an environment free of dust, corrosive gases, and salt air.
- Install the business server in a location free of vibration and on an even surface to prevent the business server from leaning.
- Do not run any cable beneath any equipment. Also, prevent cables from becoming taut. Never disconnect the power cable of the Server Unit while power is being supplied to the SE server.
- Keep objects off the rack and the rack components. Never use the rack as a work area.
- Do not allow condensation to form. In winter, slowly raise the ambient room temperature to prevent condensation from forming in the Server Unit.
- Use the SE server only after it has warmed up sufficiently.
- Operate the SE server away from noise-generating sources, such as photocopiers, air conditioners, and welding equipment.
- Take preventive measures to control electrostatic buildup. Note that carpets often generate static charge which may cause the SE server to malfunction.
- When moving the business server, do not pull on the front cover. Doing so may cause damage to the SE server.

3 System overview and features

The Fujitsu Server BS2000 SE Series comprises several models whose total operating performance is determined by the number of CPUs in the Server Unit. All models have at least one CPU for the BS2000 operating system BS2000 OS DX.

A Fujitsu Server BS2000 of the SE Series (SE server for short) consists of the following components:

- **Management Unit (MU) with SE Manager**

An autonomous server known as the "Management Unit" (MU) is integrated into the rack for monitoring and central operation of the system.

For SU /390 the MU performs SVP operation.

Remote service of the SE server is performed by means of AIS Connect (over the internet). For AIS Connect the Management Unit requires an internet access over the administration LAN. The customer operates the access for remote service via the SE Manager.
- **Server Unit**

A /390-based Server Unit (SU /390) as well as an x86-based Server Unit (SU x86) enables operation of BS2000 (Native BS2000 or VM2000).

In the basic configuration the SE server is equipped with one Server Unit:

 - SE /390 in its basic configuration with one SU /390
Several models with 1 to 16 processors are available.
 - SE x86 in its basic configuration with one SU x86
The SU x86 provides BS2000 performance solely on the basis of x86 technology. Several models are available with 1 to 16 Xeon processor cores. In terms of processor performance, configurability and scalability of the monoprocessor performance, the SU x86 models range below the SU /390 models.

SE servers SE730 / SE730B can optionally be equipped with additional SU330s / SU330Bs. SE servers SE710, SE310, SE320 and SE330 / SE330B contain exactly one SU.
- **Net Unit, for SU /390 with HNC**

Gigabit Ethernet Switches are integrated into the rack for internal communication. In the case of SE /390, the Net Unit is by default redundant in design. In the case of SE x86, redundancy of the Net Unit is optional. In the case of SE /390 one or more HNCs provide the LAN connections for the SU /390.
- **Rack console and KVM switch**
- **Application Unit (AU)**

Optionally up to 256 AUs can be operated on the SE server for customer applications. An x86-based AU permits operation under Linux, Windows, VMware ESXi or other hypervisors.
- **Peripherals (storage)**
- **Optional hardware components:**
 - To store user data, optional disk storage systems can be installed in the basic racks and connected to SU x86: ETERNUS DX100 to SU310, SU320 and SU330 / SU330B.
Additional disk storage systems (e.g. ETERNUS DX or ETERNUS AF) can be connected to all Server Units via Fibre Channel.
 - For backup of user data, tape libraries can optionally be installed in the basic racks and connected to SU x86: ETERNUS LT140 to SU310, SU320 and SU330 / SU330B.
ETERNUS CS8000 virtual tape libraries can be connected to all Server Units via Fibre Channel.
 - Rack-mountable storage systems and FC switches can be installed in the basic racks or extension racks if they are approved for use on Server Units or Application Units.

All components of the SE server are integrated into a joint rack (depending on the configuration, further racks are optionally possible). Information on the current hardware configuration of your SE server is displayed by the SE Manager in the *Hardware -> HW inventory* menu (see the "Operation and Administration" manual [5]).

Detailed information on the installation data, in particular on the dimensions and weights, is provided in the data sheet "Fujitsu Server BS2000 SE Series".

See the product site for the relevant server at <https://www.fujitsu.com/emeia/products/computing/servers/mainframe/bs2000/>:

- > Go to *Fujitsu Server BS2000* and select the desired SE server model.

3.1 Rack of the SE server

SE310 / SE320 / SE330 / SE330B

The following figure shows exemplarily how the basic rack of the SE servers SE310, SE320 resp. SE330 / SE330B is equipped with the components of the basic configuration and with optional components.

The rack height is 42 height units. An SU310 requires two height units, SU320 and SU330 / SU330B require three height units each.

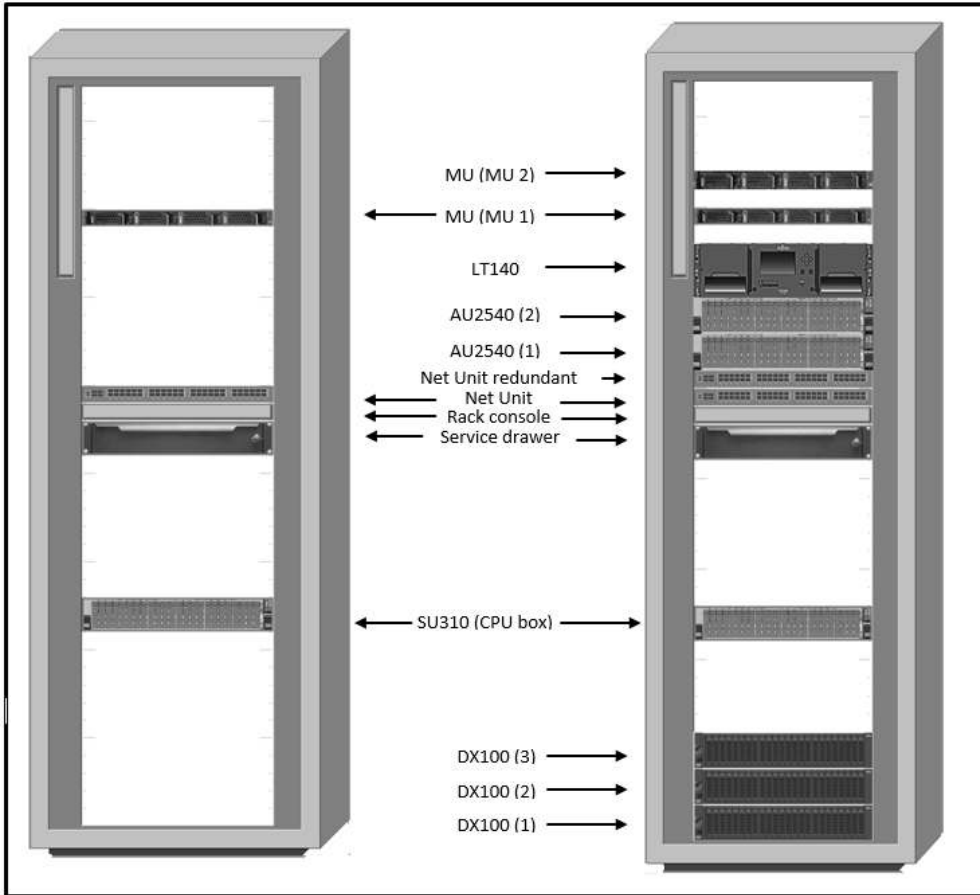

Figure 2: System components SE310/SE320/SE330/SE330B (basic configuration on the left, with optional components on the right)

SE710 / SE730 / SE730B

The following figure shows exemplarily how the basic rack of the SE servers SE710 resp. SE730 / SE730B is equipped with the components of the basic configuration and with optional components.

The rack height is 42 height units.

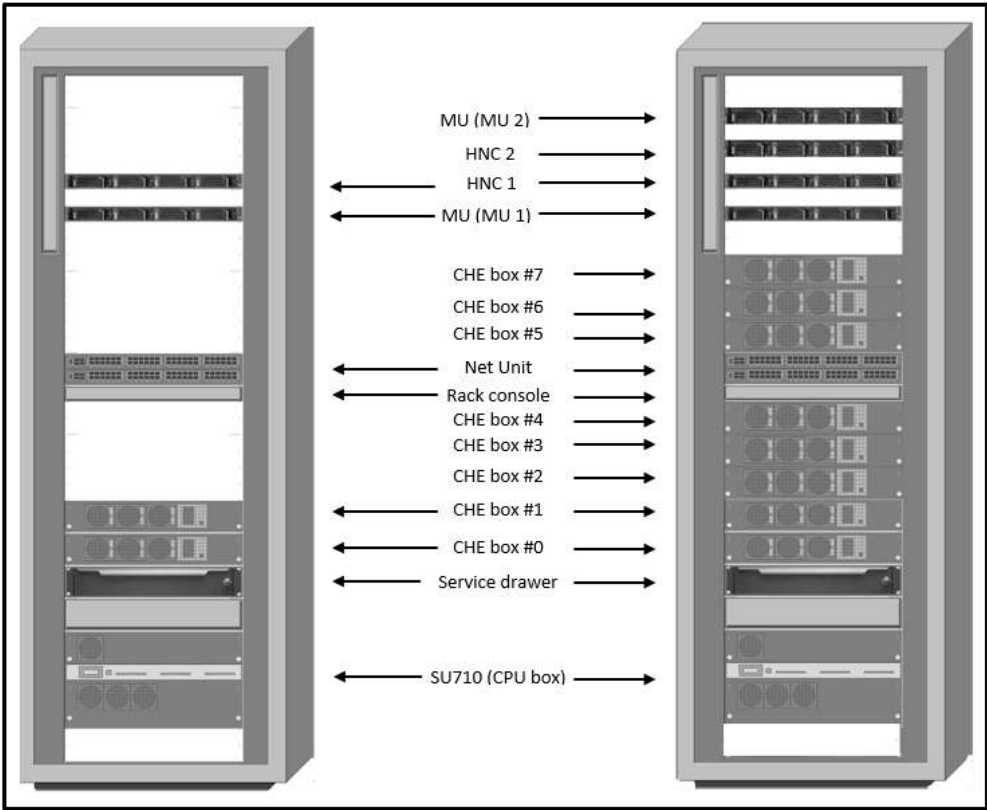

Figure 3: System components SE710/SE730/SE730B (basic configuration on the left, with optional components on the right)

3.2 Expanded maintenance and operational functions

The equipment maintenance feature of the SE server is designed to prevent fault events occurring. The Management Unit monitors the hardware status of the Management Unit, Server Unit(s) and Application Unit(s). Detected faults are displayed in the SE Manager and reported to the vendor's Support Center via remote service.

At every Management Unit, the SE Manager shows the hardware status of all Management Units, Server Units and Application Units of the respective SE server configuration. Accordingly, in the case of a Management Cluster the Units of the involved SE Servers are monitored.

The Event Logging of the SE Manager logs events that have occurred. SE Manager's Alarm Management allows you to notify management systems by SNMP trap or users by e-mail when certain events occur.

! CAUTION!

You are forbidden from repairing components of the server yourself. Maintenance and repair of the server components are performed solely by Customer Support. If a fault occurs, please always contact Customer Support.

Detailed information on the monitoring functions is provided in the "Operation and Administration" manual [5].

4 Racks

The description is divided into the following sections:

- [Basic rack](#)
- [Extension rack](#)
- [Power supply](#)

4.1 Basic rack

The components of the SE server are integrated into the basic rack, a 19-inch standard rack. In the case of the SE710 and SE730 / SE730B, the control panel is located on the front (see [section "Control panel \(on the SE /390\)"](#)). If the basic rack is not longer adequate for larger configurations, extension racks can be used.



Figure 4: Basic rack (SE730 / SE330)

4.2 Extension rack

The extension rack is a 19-inch standard rack which accommodates additional components for which there is no more space in the basic rack.



Figure 5: SE710 with two extension racks

A total of four expansion racks can be added to an SE server.

4.3 Power supply

The devices in the racks are supplied with power over power distribution units (PDUs).

SE /390

By default a basic rack contains four PDUs, each with 11 usable C13 outlets.

Each PDU is connected to the in-house power grid with CEE connectors 16A blue. For redundancy reasons, two phases are required. Two of the four CEE connectors are connected to each phase.

SE x86

The power distribution units to be installed in the SE x86 basic rack and in the extension racks can be selected. The following three types of PDU can be installed:

- PDU with 11 usable C13 outlets, CEE connector 16A blue
- 3-phase PDU with 3 x 8 x C13 outlets, CEE connector 16A red
- PDU with 8 x C13 outlets, CEE connector 32A blue

Connection of the power cables

Most of the hardware components in the SE server rack do not incorporate any switches which disconnect them from the power source. Consequently the power cables of the hardware components must be attached or detached when it is necessary to connect or disconnect the components from the power source.



Figure 6: Example of a power distribution unit as used in the rack

! **CAUTION!**
Equipment damage

- All work on the power supply must be conducted by Customer Support.
- Connect each power cable to a grounded service outlet located within the operator's reach.
- The power cables must be connected in such a manner that the power consumption of the rack components does not exceed the maximum rated current of the circuit's fuse and the maximum permissible current of the fuses in the power distribution unit in the rack.
- Free sockets in the power distribution unit may not be used to connect other devices. The total permissible current for a power distribution unit could be exceeded if other devices were connected. If you have additional requirements, please contact Customer Support.

5 Controls

The description is divided into the following sections:

- Rack console
- Console switch
- Control panel (on the SE /390)
 - Function of the displays
 - Function of the keys and switches

5.1 Rack console

The rack console contains the following in a compact 19" slide-in housing (1 height unit):

- A fold-out 17" TFT color LCD monitor with a control panel and screen menu
- A keyboard with US/international assignment with an integrated number pad
- A touchpad with a scroll bar
- Left and right mouse buttons

Monitor, keyboard and touchpad are protected in the slide-in module.

The rack console serves as the local console:

- Entries from the rack console are normally transferred to the Management Unit.
Outputs to the rack console normally come from the Management Unit, depending on the setting of the console switch, see [section "Console switch"](#).
- After you have logged in on the local console, you can call the SE Manager via the local desktop's browser.

Safety instructions

- Pull the rack console slowly toward you until the slide rails lock. If the slide rails are not locked, the rack console can move unexpectedly. Be careful not to catch your fingers when you pull or push on the slide module or when you open or close the LCD, etc.
- Do not apply any strong force to the rack console when it is pulled out or when the monitor is opened and being used.
- Do not press strongly on the monitor's screen, scratch it with sharp objects, or bring magnetic objects near it. Doing so can damage the monitor.
- Note that the corners of the open device can be dangerous if bumped into. Always be careful when the device is open.
- We recommend that you store the rack console in the rack when not in use.

Sliding the rack console out of the rack



- > Loosen the finger screws (1)
- > Pull the rack console while you hold the handle (2) until it locks into place.

Opening the rack console



- > Use the handle to push the cover of the rack console up until the monitor is open at an angle of 110 degrees.

Monitor operating panel

The operating panel is at the bottom right of the monitor.

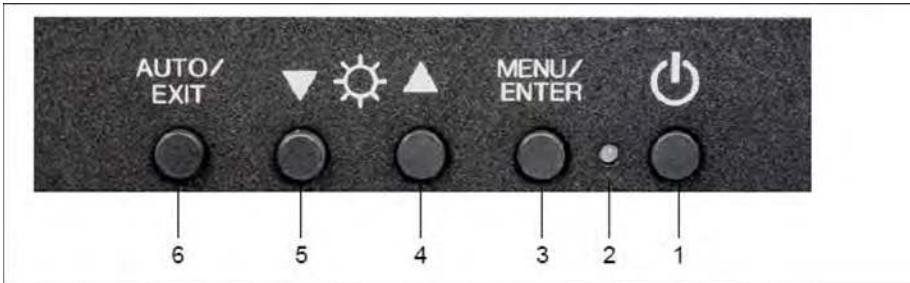

- 1 Power button
Press this button to turn on the power to the monitor, or, if the power is already on, to turn off the power to the monitor.
- 2 Power LED
This LED lights up green when the power to the monitor is on, and lights orange when the monitor is in energy-saving mode. The light goes off when the monitor is turned off.
- 3 MENU/ENTER button
Press this button to open the menu, to select an item to be adjusted, and to save an adjusted setting.
- 4 UP button
Press this button to select the right-hand item or to increase the value.

5 DOWN button

Press this button to select the left-hand item or to increase the value.

6 AUTO/EXIT button

Press this button to close the menu, to cancel the selection of an item to be adjusted, to cancel an adjusted setting, or to perform automatic adjustment.

i It is possible to directly adjust the screen brightness by pressing the UP or DOWN button when the menu is not displayed.
It is possible to perform automatic adjustment (position and focus) by pressing the AUTO/EXIT button.

Menu control

> Press the MENU/ENTER button (3).

The main menu is opened. The menu item selected is highlighted.

> Use the UP and DOWN buttons (4 and 5) to go to the required menu item.

> Select an item with the MENU/ENTER button (3). The list entry selected is highlighted.

> Use the MENU/ENTER button (3) and the UP and DOWN buttons (4 and 5) to add the settings to the list entries selected.

> Confirm each of your settings by pressing the MENU/ENTER button (3).

> Quit the list entry, the menu item and the menu using the AUTO/EXIT button (6).

Switching the monitor on

> Press the power button (1) to turn the monitor on.

Notes on the LCD Display

- While the on-screen display may shift, blink, or otherwise be disturbed just after the power is turned on or the OS starts up/shuts down, this does not indicate a machine failure, and the device may be used normally.
- While 1280 × 1024 is the native full-screen resolution, the LCD display is full screen for all resolutions. For resolutions other than 1280 × 1024, characters may be blurred and the thickness of thin lines can be uneven. This is because the full-screen display is made by digital interpolation of the low-res output, not by physical magnification. This is not a machine failure, and the device may be used normally.
- Although there might be some always-off dots or some always-on dots, this is accepted as it is a natural characteristic of LCDs, not as a fatal imperfection. So use this device normally.

Keyboard operations

Using the Fn key on the compact layout keyboard of this device allows functions equivalent to a full keyboard.

- By pressing both the Fn key and a key with underscored characters, you can use the function indicated by the characters (for example, Scr Lk, Prt Sc, and SysRq).

- When the Num Lock LED is lit, the functions indicated by the enclosed characters shown on some keys are enabled.



HOT-KEY and RESET key

The following indicators and buttons are located on the right above the keyboard.

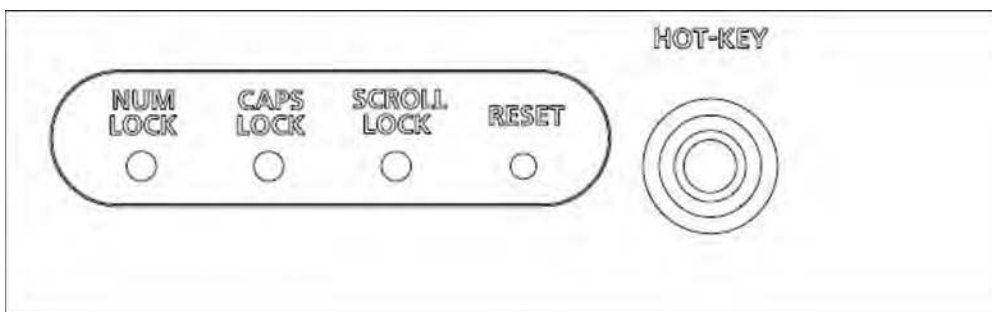

HOT-KEY Pressing the HOT-KEY (outputs the code of the CTRL key twice) causes the menu of the connected console switch to be called.

RESET Resets the keyboard and pointing device on this device.

Pointing device operations

When you operate the pointing device, touch or tap lightly on the touchpad surface.

Moving the pointer

Slide your finger lightly on the touchpad surface in the direction you want to move the cursor.

Single clicking

Lightly tap the touchpad surface once, or click the left button once.

Double clicking

Lightly tap the touchpad surface twice, or click the left button twice.

Dragging

Lightly tap the touchpad surface twice and without releasing your finger from the touchpad surface, slide your finger to move the cursor to the desired position, and then release your finger from the surface. Or, while holding down the left button, slide your finger to move the cursor to the desired position, and then release your finger from the touchpad surface.

Scrolling

Slide your finger up or down along the right edge of the touchpad surface to scroll up or down the screen.

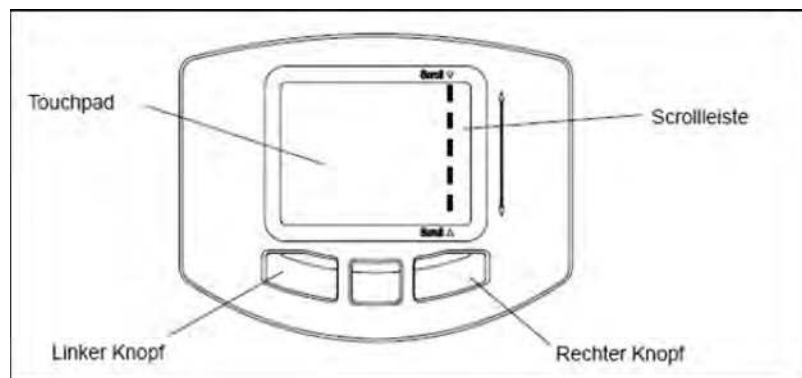

Notes on the pointing device

The pointing device does not work correctly if you operate it in the following ways:

- Operating the pointing device with a gloved finger
- Operating the pointing device with a pen, ballpoint pen, or pencil
- Operating the pointing device with two or more fingers
- Operating the pointing device while something is on the touchpad
- Operating the pointing device while water drops are on the touchpad surface, while condensation is formed on the touchpad surface, or with a wet finger

If the touchpad surface or your finger is wet, dry or wipe water well before you use the touchpad. Do not use a pointed metal object such as a pen. Doing so may damage the touchpad surface.

Switching the monitor off

- > Press the monitor power button (see "[Power button](#)") to turn off the monitor.

Closing the monitor



- > Make sure that the front USB connector (1) is empty before closing the monitor. It is not envisaged for use with the SE server.
- > Use the handle (2) to push the cover of the rack console carefully down until it clicks into place.

Sliding the rack console into the rack



- > Press the buttons (1) to release the rack console.
- > Use the handle to slide the rack console into the rack until it clicks into place (2).
- > Tighten the finger screws (3)

Troubleshooting

No image is displayed on the monitor:

Symptom	Cause	Action
The power LED is out.	The power is not turned on.	Press the power button.
	The monitor does not function correctly after being turned on.	Notify Customer Support.
The power LED is orange. Or, when the MENU/SELECT button is pressed, the message "Signal Going to Sleep" is displayed.	The server is in standby mode.	
	The monitor is incorrectly connected to the server.	Notify Customer Support.
The power LED lights but no image is displayed on the monitor.	The rack console was turned on after the server was turned on.	Turn on the device at the same time as or before you turn on the server.
	The monitor is incorrectly connected to the server.	Notify Customer Support.
The screen flickers.	The monitor is incorrectly connected to the server.	Notify Customer Support.

The monitor display looks strange:

Symptom	Cause	Action
Grid screen that flickers.	The monitor is unfocused.	Adjust the focus of the monitor.
Vertical stripes are visible.	Monitor adjustment is not correct.	Adjust the clock, and then adjust the display position.
Sometimes no images are displayed on the monitor.	The monitor is incorrectly connected to the server.	Notify Customer Support.
Letter weights are different across the monitor.	Focus or clock adjustment is not correct.	Adjust the clock, and then adjust the display position.

Monitor cannot be adjusted:

Symptom	Cause	Action
Automatic adjustment using the AUTO/EXIT button does not work and the following message is not displayed: "AUTO Processing"	Automatic adjustment was performed with an extremely dark monitor background/image.	Make the monitor image as bright as possible, and then press the AUTO/EXIT button to redo automatic adjustment.

5.2 Console switch

The monitor, keyboard and mouse port of the integrated rack console are connected to the corresponding ports on the integrated units (Management Unit, Server Unit x86, HNC, and Application Unit) and thus attached to one of them.

By default, the rack console is attached to the first Management Unit.

The console switch is usually a digital 8- or 16-port KVM switch. The KVM switch is integrated into the rack in a vertical position and therefore does not require a height unit.

In the maximum configuration, five KVM ports (2 x MU and 3 x SU x86) are occupied in the SE x86, and eight KVM ports (2 x MU, 4 x HNC and 2 x SU x86) in the SE /390, additional AUs where required. If more AUs are to be integrated into the SE server, the KVM switch can be replaced with a different KVM switch with 16 or 32 ports. In this case, please contact your sales representative.

5.3 Control panel (on the SE /390)

At the front of the basic rack on the SE /390, a control panel is located on the outside. The control panel is connected to the service processor (SVP) of the SU710 resp. SU730 / SU730B of the SE server.

Further information on the SU710 and SU730 / SU730B is provided in the "Server Unit /390" Operating Manual [2].

The control panel looks like this:



Figure 7: Control panel on the rack of the SE710/SE730/SE730B

The control panel contains the following controls and displays (please refer to the numbers in the figure):

1. **POWER ON** button with lamp
Switches the Server Unit on. When the SU /390 is switched on, POWER ON lights up green.
2. **STAND-BY** button
Switches the SU /390 off, but not currentless (power supply units in standby mode).
3. **SYSTEM** lamp
Displays whether the CPUs of the SU /390 are active.
4. **STATUS** indicator
Supplies detailed information on the hardware status (error code).
5. **CHECK** lamp
Shows whether a fault has occurred.

The function of the displays and controls in the control panel is described in the sections below.

5.3.1 Function of the displays

POWER ON

Lights up green after the system power controller has completed the power-up sequence without error. In the standby status the indicator flashes.

SYSTEM

Lights up green when the CPU(s) is/are in operation.

CHECK

Lights up red when the SVP has detected a hardware malfunction or a fault in the power supply of the SU /390. In the event of a fault a buzzer sounds at the same time.

STATUS indicator

Depending on the POWER ON indicator, this indicator is switched on and displays details of the hardware status with a three-character alphanumeric display.

The display changes as sequences are executed. If the display finally stops at a particular value not equal to "000", this must be interpreted as the error code for a problem. In this case Customer Support should be contacted.

POWER ON	STATUS indicator	Hardware status
Does not light up	Does not light up	Power failure
Does not light up	b00 through bFF	Power supply units are being initialized.
Flashing	Does not light up (in maintenance mode CE0)	Standby mode
Lights up	001 through 010	Power-on sequence is active.
Lights up	100 through 399	System is being initialized.
Lights up	000	System initialization completed.
Lights up	500 through 599	System stop initiated.
Lights up	010 through 001	Power-off sequence is active.
Lights up or does not light up (depending on the STATUS)	Begins with A	The entire /390 system (CPU box, AROMA, CHE boxes) or parts of it have been switched off because of a fault (power supply or operating temperature). Or an important function of the SVP has been stopped and a detailed error code cannot be displayed on the SVP console.
Lights up	EEE	Another error has occurred. A detailed error code is displayed on the SVP console.

Table 1: STATUS indicator

5.3.2 Function of the keys and switches

POWER ON key

This key initiates the sequential power-on of the power supplies of the entire /390 system (/390-CPU, AROMA, CHE boxes). They are powered on independently of an automatic power-on/off function.

IMPL (Initial Micro Program Load) is then performed. The system is ready when POWER ON lights up and the status indicator displays 000.

When POWER ON IPL is configured, the operating system is then loaded (see SVP frame LOAD PRESET1, "Server Unit /390" Operating Manual [2]).

Before pressing the POWER ON key, check whether the following requirements are met:

1. POWER ON is flashing and the status indicator displays nothing. When all displays are off and the status indicator displays nothing, the power supply of the Server Unit is switched off. In this case switch the fuses in the power distribution cabinet on to supply the Server Unit with power.
2. The status indicator displays no error code. If an error code is displayed, notify Customer Service of this error code.

Press the POWER ON key to begin powering up the system. The power-up sequence begins. POWER ON lights up and the status indicator displays a sequence from 001 through 399 while powering up.

The system is ready when POWER ON lights up and the status indicator displays 000. If the status indicator displays an error code, an error occurred while powering up. In this case notify Customer Service of this error code.

STAND-BY key

This key is used to switch off the power supply of the entire /390 system. It is switched off independently of an automatic power-on/off function.

! CAUTION!

There is a risk of data loss. When standby mode is switched to (using the key or the SVP frame), it is not guaranteed that system data can be written back. Terminate applications which are running beforehand and shut down the operating system.

! IMPORTANT!

In standby mode some of the circuits remain live!

Press the STAND-BY key to initiate system power-off. The power-off sequence begins. While the system is powering off, the status indicator displays a sequence from 501 through 599. When the Server Unit is switched off, POWER ON flashes and the status indicator display is empty.

Instead of using the key, the system can also be switched to standby using the SVP frame (AU4) POWER STAND-BY/IMPL. See the "Server Unit /390" Operating Manual [2].

6 Management Unit

An autonomous server, known as the Management Unit (MU), is integrated into the rack for central operation and administration using the SE Manager and for monitoring the units.

On the SE /390 the MU provides the SKP functionality to operate the SU /390. The MU is also the carrier system for further add-on software such as StorMan, ROBAR, openSM2, and openUTM.

On the SE /390 redundancy of the SKP functionality can be achieved by installing a second MU.

The main memory, internal disks (SSDs on MU M4 and MU M5), power supply units, and fans are redundant in design. The internal disks, power supply units, and fans can be replaced during ongoing operation.

The rack console serves as a monitor for the Management Unit and consequently as local access to the administrative and operating functions of the SE server.

The M2000 software is preinstalled ex works.

Detailed information on operating the Management Unit is provided in the "Operation and Administration" manual [5].

Detailed information on the various hardware components and interfaces of the Management Unit is provided in the data sheet "Fujitsu Server BS2000 SE Series".

See the product site for the relevant server at <https://www.fujitsu.com/emeia/products/computing/servers/mainframe/bs2000/>:

- > Go to *Fujitsu Server BS2000* and select the desired SE server model.

6.1 Front of the MU

Depending on the model of the SE server, it contains Management Units of the type MU M3, MU M4 or MU M5.

MU M3







Figure 8: Management Unit (MU) - front of an MU M3

Indicators on the front panel of MU M3



Figure 9: Indicators and control elements on the front panel of MU M3

Pos.	Label	Button / Display	Function	Status
1	RESET	Reset button	System restart (for Customer Support only)	
2	NMI	NMI button	For Customer Support only	
3	ID	ID button / ID indicator	Identifies the ID display on the front panel and at the I/O panel for an easier server identification.	blue on
4		CSS display	Notify Customer Support if on or flashing	off / orange / orange flashing
5		Global error display	Notify Customer Support if on or flashing	off / orange / orange flashing

6		HDD/SSD activity indicator	Data access running	green flashing
7		On/Off button	Switch on server: Off / Server switched on / BMC firmware starting after connection to power grid	off / green on / green flashing slowly
8		Status indicator (power cable connected)	Server switched off and connected to power grid (stand-by mode) / Server switched off and not connected to power grid or switched on and normal operation	green on / off

MU M4 / MU M5

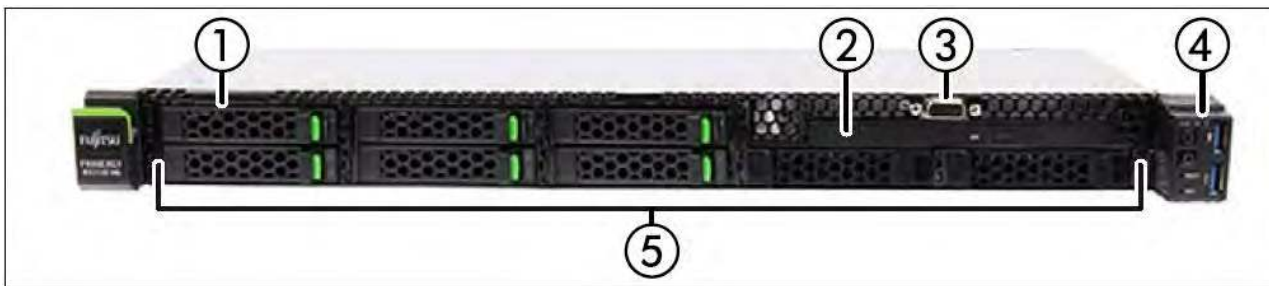

Figure 10: Management Unit (MU) - front of an MU M4 / MU M5

No.	Function
1	ID card
2	Optical drive (ODD) resp. dummy cover
3	Front VGA port (if available)
4	Common operation panel (see below)
5	HDDs / SSDs / PCIe SSDs / EDSFF SSDs / dummy modules

Indicators on the front panel of MU M4 / MU M5

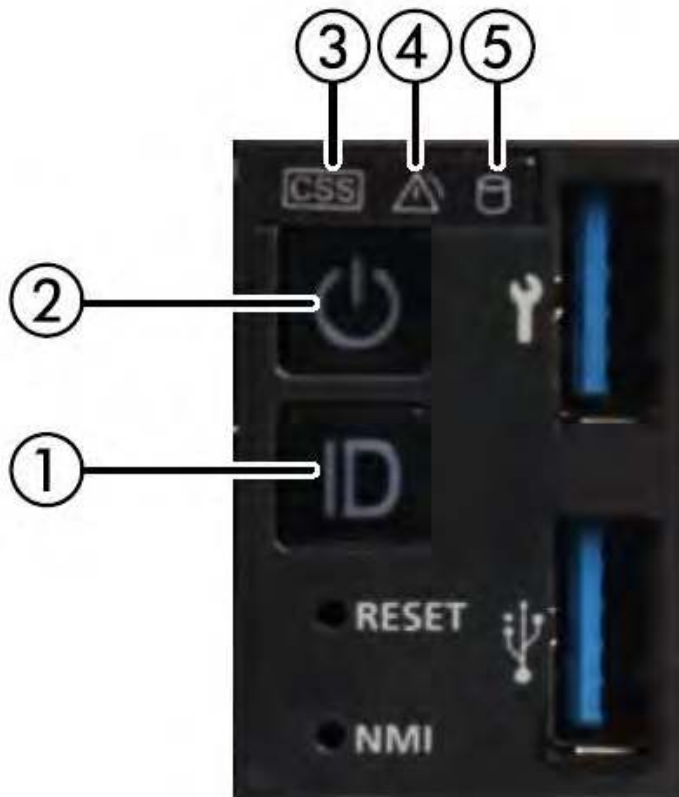





Figure 11: Indicators and control elements on the front panel of MU M4 / MU M5

Pos.	Label	Key / Display	Function	Status
1	ID	ID button / ID indicator	Identifies the ID display on the front panel and at the I/O panel for an easier server identification.	blue on
2		On/Off button	Switch on server: Off / Server switched on / BMC firmware starting after connection to power grid	off / green on / green flashing slowly
3		CSS display	Notify Customer Support if on or flashing	off / orange / orange flashing
4		Global error display	Notify Customer Support if on or flashing	off / orange / orange flashing
5		HDD/SSD activity indicator	Data access running	green flashing
	RESET	Reset button	System restart (for Customer Support only)	
	NMI	NMI button	For Customer Support only	

Schema of the front panel of MU M4 and MU M5





Figure 12: Front of the MU M4 / MU M5 (schema)

6.1.1 Controls

ID	Identification (ID) button Lights up (blue) on the front and on the rear of the MU when the ID button is pressed. The two ID indicators are synchronized.
	On/Off button When the MU is switched off, it is switched on again by pressing the On/Off button once. When the MU is in operation, it is switched off by pressing the On/Off button once. <div data-bbox="266 548 1455 680"><p>! CAUTION! Possible loss of data!</p></div> <div data-bbox="266 709 1455 821"><p>i The On/Off switch does not disconnect the server from the voltage grid. To disconnect from the mains completely, remove the power plugs.</p></div>
RESET	Reset button Pressing the Reset button reboots the MU. <div data-bbox="266 989 1455 1121"><p>! CAUTION! Possible loss of data!</p></div>
NMI	NMI button <div data-bbox="266 1236 1455 1369"><p>! CAUTION! Do not press! Possible loss of data! The NMI button may only be used by Customer Support.</p></div>

Indicators on the operating panel

	Power-on indicator (three colors)
	<p>Lights up orange when the MU is switched off but line voltage is present. After the power cables have been connected, it takes about 60 seconds until the MU is in standby mode.</p> <p>Lights up yellow during power up delay.</p> <div style="background-color: #e6f2ff; padding: 5px; border: 1px solid #add8e6;"> <p>i If the MU is switched off and then immediately switched on again, it is only restarted after a power up delay. This prevents a current overload, for example.</p> </div> <p>Lights up green when the MU is switched on.</p> <p>Flashes green when the MU has been switched on and is in standby mode or in sleep mode.</p>
	<p>Hard disk activity indicator (green)</p> <p>Flashes green when an internal hard disk drive is being accessed.</p>
CSS	CSS and Global error indicators (yellow/orange)
	<p>Generally, the states of these indicators have the following meanings:</p> <ul style="list-style-type: none"> • Do not light up when the MU is OK. • If the event is still acute after a power failure, the indicator is activated after the restart. • Light up when a prefailure event was detected. The indicator also lights up in standby mode. • Flash when an error was detected. The indicator also flashes in standby mode. <p>Irrespective of the color, when an indicator lights up or flashes this indicates an error event. Please notify Customer Support when this happens.</p>
ID	<p>ID indicator (blue)</p> <p>Lights up blue when MU has been selected by pressing the ID button. To deactivate, press the button again.</p>

Optical drive activity indicator

Lights up green when the storage medium is accessed. See also [figure 9/11](#).

Hard disk drive control indicators



Figure 13: Front - Detailed view: Indicators on a hard disk module

1	<p>HDD BUSY (green)</p> <ul style="list-style-type: none">• Lights up: HDD in active phase• Does not light up: HDD inactive
2	<p>HDD FAULT (orange) (in conjunction with a RAID controller)</p> <ul style="list-style-type: none">• Does not light up: no HDD error• Lights up: HDD Faulty or Rebuild Stopped (drive defective, needs replacing, a rebuild process was stopped or the HDD module is not correctly inserted)• Slow flashing: HDD Rebuild (the data is being restored after changing a hard disk drive)• Fast flashing: HDD Identify• Four fast flashes/pause: HDD Predicted Fault• Two fast flashes/pause: HDD Hot Spare (The corresponding drive has failed).

6.2 Rear of the MU



Figure 14: Management Unit (MU) - rear of an MU M3

Figure 14 shows the rear of an MU M3 with PCIe slots which are not equipped.

ID/CSS/Global error indicator

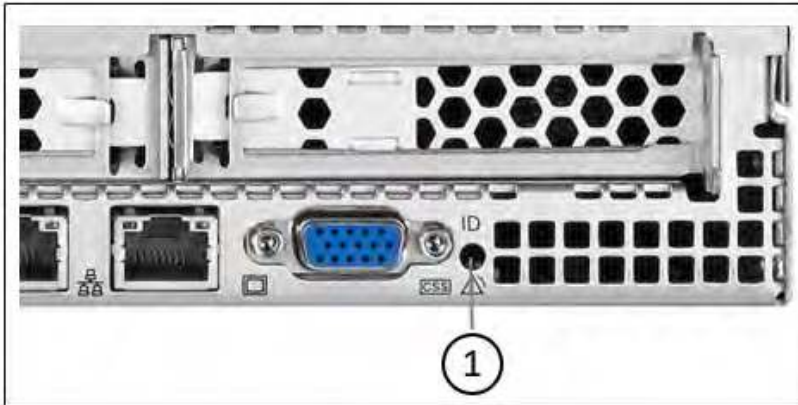



Figure 15: ID/CSS/Global error indicator (MU M3)

1	ID/CSS/Global error indicator
ID	<p>ID indicator (blue)</p> <p>Lights up blue when the MU has been selected by pressing the ID button. To deactivate, press the button again.</p> <p>The ID indicator can also be activated via the ServerView Operations Manager and the iRMC S<n> web interface, and the status can be reported to the ServerView Operations Manager and the iRMC S<n>.</p>
CSS	CSS and Global error indicator (yellow/orange)
	<p>Generally, the states of these indicators have the following meanings:</p> <ul style="list-style-type: none"> • Do not light up when the MU is OK. • If the event is still acute after a power failure, the indicator is activated after the restart. • Light up when a prefailure event was detected. The indicator also lights up in standby mode. • Flash when an error was detected. The indicator also flashes in standby mode. <p>Irrespective of the color, when an indicator lights up or flashes this indicates an error event. Please notify Customer Support.</p>

LAN indicators

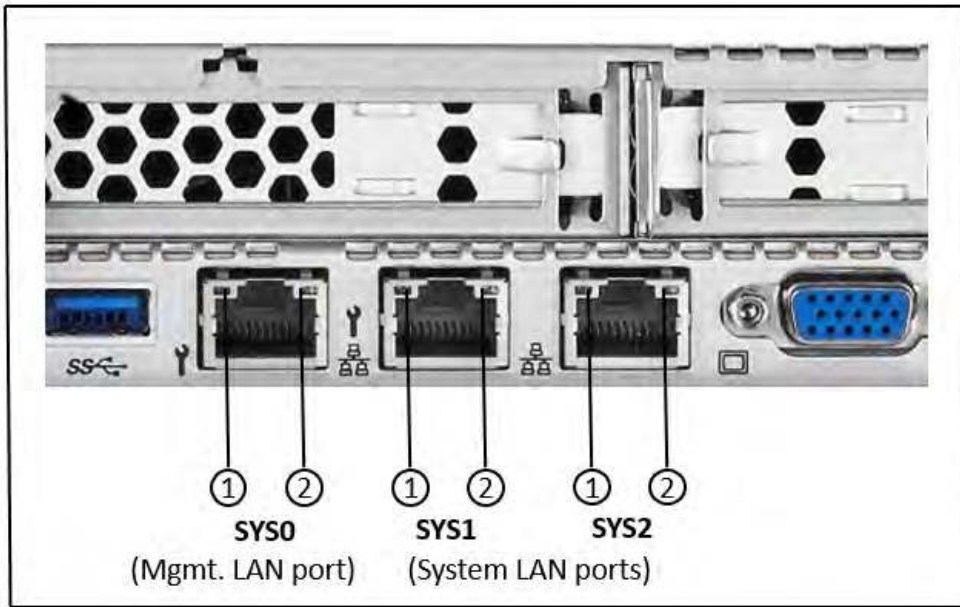

Figure 16: LAN indicators (MU M3)

1	LAN speed	<p>Lights up green for a LAN transfer rate of 1 Gbps.</p> <p>Lights up green for a LAN transfer rate of 100 Mbps.</p> <p>Does not light up for a LAN transfer rate of 10 Mbps.</p>
2	LAN connection/transfer	<p>Lights up green if a LAN connection exists.</p> <p>Does not light up if no LAN connection exists.</p> <p>Flashes green when a LAN transfer is in progress.</p>

Indicator on hot-plug power supply unit

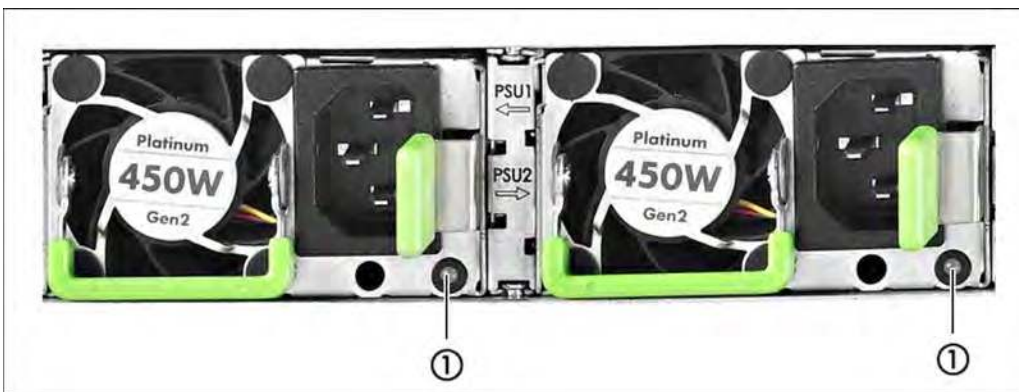

Figure 17: Indicator on hot-plug power supply unit

- | | |
|---|---|
| 1 | <ul style="list-style-type: none"> • Flashes green when the MU is switched off, but line voltage is present (standby mode). • Lights up green when the MU is switched on and functioning properly. • Flashes orange when a predictable error has been detected, but the power supply unit is still running. ¹⁾ |
|---|---|

- **Flashes orange** in the case of OCP/OVP or when the power supply unit's fan has failed.

1) The following events are detected as predictable errors:

- The temperature is very high.
- The power consumption is very high.
- The strength of current is very high.
- The fan speed is very low.

In each of these cases please notify Customer Support.

Assignment of the PCIe slots

The assignment of the PCIe slots differs between MU M3 and MU M4.

PCIe slot assignment on the MU M3

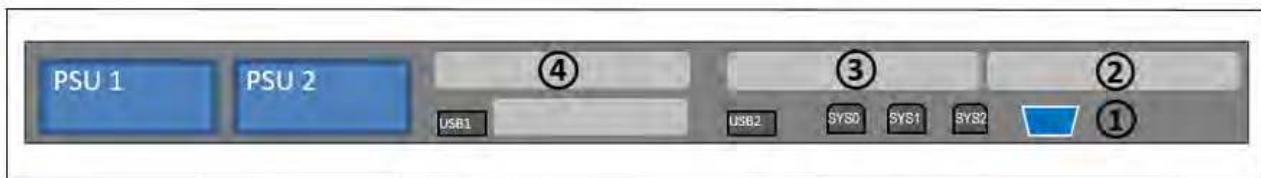

Figure 18: Principle of PCIe slot assignment at the rear of the device (MU M3)

The figure shows the PCIe slots of the MU M3 on an SE710. On the various model series of the SE server, the PCIe slots of an MU M3 are assigned as follows:

PCIe slot	SE710	SE310/SE320
S2	FibreChannel card	optional FibreChannel card (CRD)
S3	optional FibreChannel card (CRD)	optional FibreChannel card (CRD)
S4	not assigned	not assigned

Table 2: PCIe slot assignment on an MU M3

The MU M3 can be equipped with another FibreChannel card in the free PCIe slot S4. Accordingly, two more ports are available for the ROBAR connection and cluster functionality.



Figure 19: Management Unit (MU) - rear of an MU M4

No.	Function
1	Up to two hot-plug power supply units
2	PCIe slot 3
3	PCIe slot 2
4	PCIe slot 1
5	OCP module 1
6	I/O panel
7	OCP module 2 (unused)

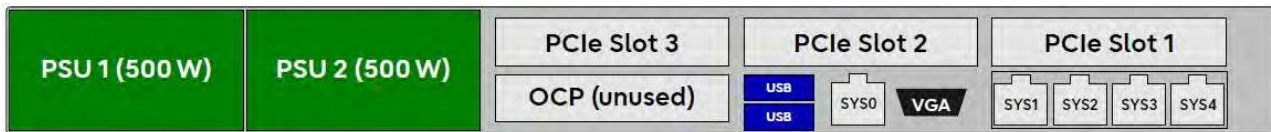

Figure 20: Schematic view of the rear of an MU M4

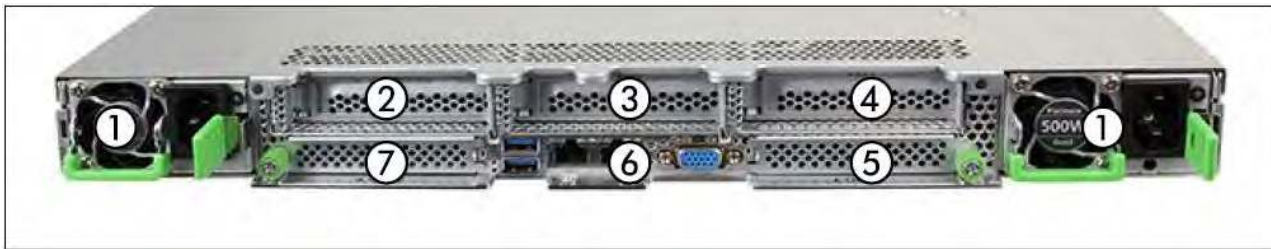

Figure 21: Management Unit (MU) - rear of an MU M5

No.	Function
1	Up to two hot-plug power supply units
2	PCIe slot 3
3	PCIe slot 2
4	PCIe slot 1
5	OCP module 1
6	I/O panel

7	OCP module 2 (unused)
---	-----------------------

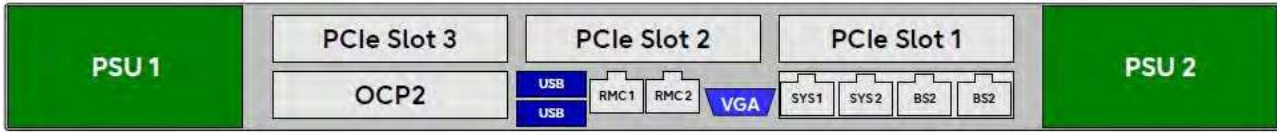

Figure 22: Schematic view of the rear of an MU M5

7 Net Unit

The Net Unit implements the connection of the units to the networks of the SE server and to private customer networks. The Net Unit can be designed with redundancy in the interest of protection against failure.

The Net Unit contains the following components:

- Switches
A redundant Net Unit has redundant switches (by default in the case of SE /390).
- HNC in SE /390
The HNC connects the Server Unit /390 with the LAN. Up to four HNCs are possible.

7.1 Switches

On the SE servers SE310, SE320 and SE710, Brocade switches ICX 7450-48 are used. These are designed redundantly with SE /390, with SE x86 there is a redundancy extension (2nd switch) in addition to one switch in the basic configuration.

On the SE servers SE330 / SE330B and SE730 / SE730B, however, the Net Unit is equipped with Juniper EX3400-48T-AFI switches.

i Currently maximum transfer speeds of up to 10 Gbps are supported.

7.1.1 Brocade switches

Brocade switches are used on the Net Unit of an SE310, SE320 and SE710.

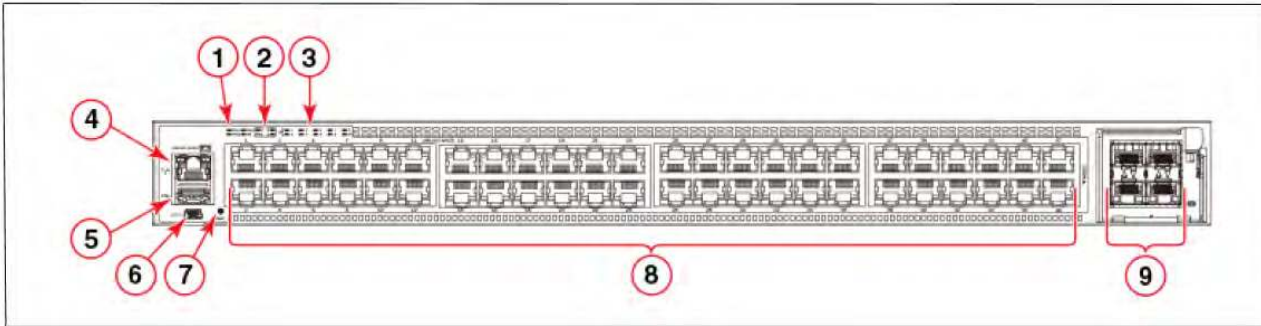

Figure 23: Net Unit (Brocade ICX 7450-48) - front

1	System LEDs
2	Media/Stacking module LEDs
3	Stack unit ID display
4	Management port (RJ-45)
5	USB port (for flash drive)
6	Mini-USB console port
7	Reset button
8	10/100/1000Base-T RJ-45 ports 1/1/1 - 1/1/48
9	SFP+ ports 1/2/1 - 1/2/4

7.1.2 Juniper switches

Juniper switches are used on the Net Unit of an SE330 / SE330B and SE730 / SE730B.



Figure 24: Net Unit (Juniper EX3400-48-AFI)

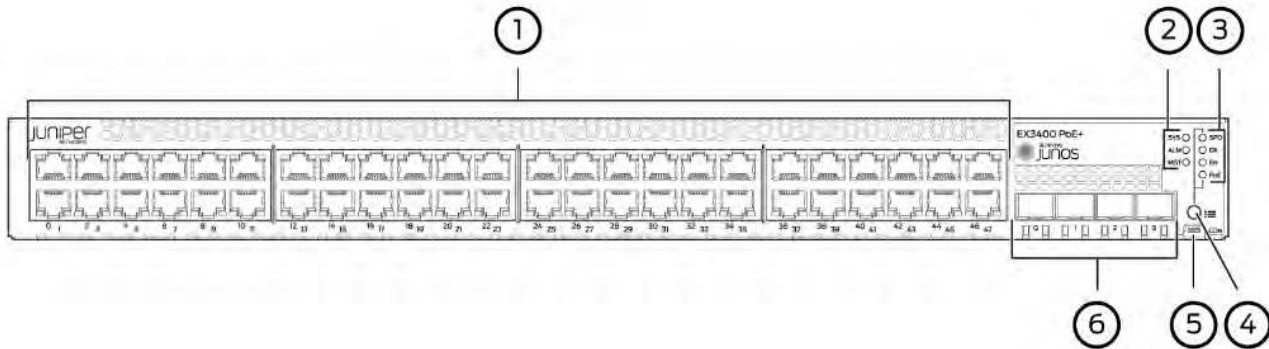

Figure 25: Net Unit (Juniper EX3400-48-AFI): Ports and control panel scheme

1	RJ-45 ports
2	Chassis status LEDs
3	Port status mode LEDs
4	Factory Reset/Mode button
5	Mini-USB console port
6	Uplink ports

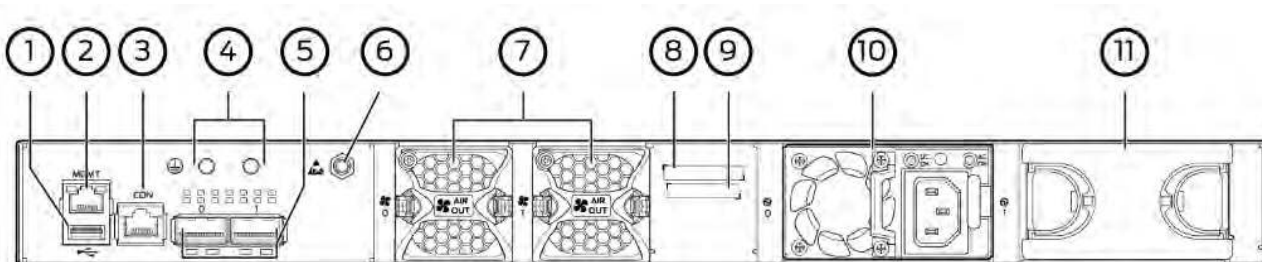

Figure 26: Net Unit (Juniper EX3400-48-AFI): Connections scheme



1	USB port
2	Management Ethernet port
3	RJ-45 console port
4	Protective earthing terminal
5	QSFP+ uplink ports
6	ESD point
7	Fan modules
8	CLEI code label
9	Serial number ID label
10	AC power supply
11	2. AC power supply (covered in the scheme)

7.2 Extension of the Net Unit

Redundant Net Unit

A redundant Net Unit has two redundant switches. The SE servers SE /390 have a redundant Net Unit already in the basic configuration. The redundant Net Unit is optional for the SE x86.

On a redundant Net Unit the ports are monitored, and when an active uplink port fails, the remaining port is switched to. When the LAN segment concerned fails, the downtime is consequently reduced to the switchover time.

HNC (High-speed Net Connect) on the SE /390

The High-speed Net Connect (HNC for short) connects the Server Unit /390 with the LAN. Furthermore, as net client the HNC permits access to the Net-Storage. The SE servers SE /390 therefore incorporate an HNC in their basic configuration.

Redundancy of the HNC is an optional feature. Up to four HNCs can be integrated.

Further information on the HNC is provided in the "Server Unit /390" Operating Manual [\[2\]](#).

8 Switching the server on and off

The description is divided into the following sections:

- Switching the SE x86 on and off
 - Switching off in an emergency
 - Switching the SE server on
 - Switching the SE server off
- Switching the SE /390 on and off
 - Switching off in an emergency
 - Switching the SE server on
 - Switching the SE server off

8.1 Switching the SE x86 on and off

Normally the Management Unit, Server Unit and Application Units are switched on and off via remote administration PCs, see the information in the “Quick Guide” [7].

This chapter describes the actions for switching these units on/off which can be performed directly on the SE server SE x86 as an alternative to switching it on/off remotely.

Further information on this subject and also on the subjects IPL, console and SE Manager is provided in the “Operation and Administration” manual [5].

8.1.1 Switching off in an emergency

The SE servers SE x86 comply with the relevant safety regulations for IT equipment, including electrical office equipment.

In an emergency all the hardware components must immediately be disconnected by cutting off the power distribution units from the power source (e.g. when the housing or power cable is damaged or liquid or foreign material gets into the equipment).

! CAUTION!

Operation of the SE server SE x86 is then terminated ungracefully and abruptly.
Notify Customer Support.

If despite the emergency there is still time enough, you can also switch off Server Unit(s), Application Unit(s) and Management Unit manually via the operating panel at the front of the unit (for the MU see [figure 9/11](#), and for the SU and AU see the "Server Unit x86" [3] and "Additive Components" Operating Manuals [4]). Optional hardware components have their own On/Off switches or are switched on/off automatically together with the Server Unit.

! CAUTION!

These do not disconnect the hardware components completely from the power source. To cut the entire system off from the power source, you must disconnect the power distribution units from the power source.
Notify Customer Support.

8.1.2 Switching the SE server on

The following hardware components must be switched on in this order:

1. Switch on the optional hardware components

- > Switch on the ETERNUS LT140 tape library as well as the ETERNUS DX100 S4/S5 disk storage system using the On/Off switch at the front (see the "Additive Components" Operating Manual [4]).
- > Switch on any other connected hardware components.

2. Switch on the MU

The power-on indicator (item 7 resp. 2 in [figure 9/11](#)) does not light.

- > Switch on the rack console by pulling out and folding out the monitor, see "[Rack console](#)".
- > Press the On/Off switch on the MU (item 7 resp. 2 in [figure 9/11](#)).

The power-on indicator lights up green. The MU switches itself on, conducts a system test and starts the M2000 software. This takes a little time. Finally, on the rack console you see the login window for the Linux desktop of the local console.

- > Call the SE Manager, e.g. after logging in on the local console via the browser of the Linux desktop (in the "Computer" menu in the task bar) or via an administration PC (default), see the "Operation and Administration" manual [5].

You can also switch on the MU remotely via the iRMC of the MU, see the "Operation and Administration" manual [5].

3. Switch on the Server Unit

Before the Server Unit is switched on, the status indicator lights up orange.

- > Switch on the Server Unit by pressing the On/Off switch.

The power-on indicator lights up green. The Server Unit switches on, conducts a system test and starts X2000.

If automatic IPL is configured for BS2000, the BS2000 system (Native or as a VM2000 monitor system) is also started with the configured settings.

i The controls and indicators of the Server Unit are described in the "Server Unit x86" Operating Manual [3].

Further optional Server Units are switched on in the same way.

4. Switch on the optional Application Units

Before an Application Unit is switched on, the status indicator does not light.

- > Switch on the Application Unit by pressing the On/Off switch.

The power-on indicator lights up green. The Application Unit switches on, conducts a system test and starts the operating system.

i The controls, indicators and further on/off options for the AU are described in the "Additive Components" Operating Manual [4].

Further optional Application Units are switched on in the same way.

8.1.3 Switching the SE server off

The following hardware components must be switched off in the specified order.

! CAUTION!

This does not disconnect the hardware components completely from the power source (POWER STANDBY). To cut the entire system off from the power source, you must disconnect the power distribution units from the power source.

Notify Customer Support.

1. Switch off the optional Application Units

Before an Application Unit is switched off, the power-on indicator lights up green.

- > Terminate the customer applications and the operating system properly.

The Application Unit is switched off automatically and enters standby mode.

The status indicator no longer lights up. Check this before continuing.

i If the operating system does not automatically switch off the Application Unit, hold the On/Off switch down for at least four seconds.

Alternatively, as administrator, AU administrator or power operator you can switch the Application Unit off using the SE Manager (menu *Hardware -> Units, Units* tab, *Power off* icon), see the "Operation and Administration" manual [5].

i The controls, indicators and further on/off options for the AU are described in the "Additive Components" Operating Manual [4].

Further Application Units are switched off in the same way.

2. Switch off the Server Unit

- > As an administrator, BS2000 administrator, an authorized BS2000 operator or a power operator, switch off the Server Unit using the SE Manager (menu *Hardware -> Units, Units* tab, *Power off* icon), see the "Operation and Administration" manual [5].

When the Server Unit is switched off, the BS2000 system is shut down properly taking into account the remaining runtime specified.

Before the Server Unit is switched off, the power-on indicator lights up green, and after it has been switched off, it no longer lights up. Check this before continuing.

i The controls and indicators of the Server Unit are described in the "Server Unit x86" Operating Manual [3].

Further Server Units are switched off in the same way.

3. Switch off the MU

- > Switch off the MU using the SE Manager (menu *Hardware* -> *Units*, *Units* tab, *Power off* icon), see the "Operation and Administration" manual [5].

Before the MU is switched off, the power-on indicator lights up green, and after it has been switched off, it no longer lights up (item 7 resp. 2 in [figure 9/11](#)). Check this before continuing.

4. Switch off the optional hardware components

- > Switch off the ETERNUS LT140 tape library as well as the ETERNUS DX100 S4/S5 disk storage system using the On/Off switch on the front (see the "Additive Components" Operating Manual [4]).
- > Switch off any other connected hardware components.

8.2 Switching the SE /390 on and off

Normally the Management Unit, Server Unit and Application Units are switched on and off via remote administration PCs, see the information in the “Quick Guide” [7].

This chapter describes the actions for switching these units on/off which can be performed directly on the SE server SE /390 as an alternative to switching it on/off remotely.

Further information on this subject and also on the subjects IPL, console and SE Manager is provided in the “Operation and Administration” manual [5].

8.2.1 Switching off in an emergency

The SE servers SE /390 comply with the relevant safety regulations for IT equipment, including electrical office equipment.

In an emergency the devices must immediately be switched off (e.g. when the housing or power cable is damaged or liquid or foreign material gets into the equipment). This can be done by pressing the POWER STAND-BY button on the server's control panel.

Pressing the POWER STAND-BY button does not disconnect the system completely from the power source. To cut the entire system off from the power source, the fuses from the customer's in-house installation must be switched off/removed.

Please then notify Customer Support.

8.2.2 Switching the SE server on

The figure below shows the hardware involved in switching the Server Unit /390 on/off.

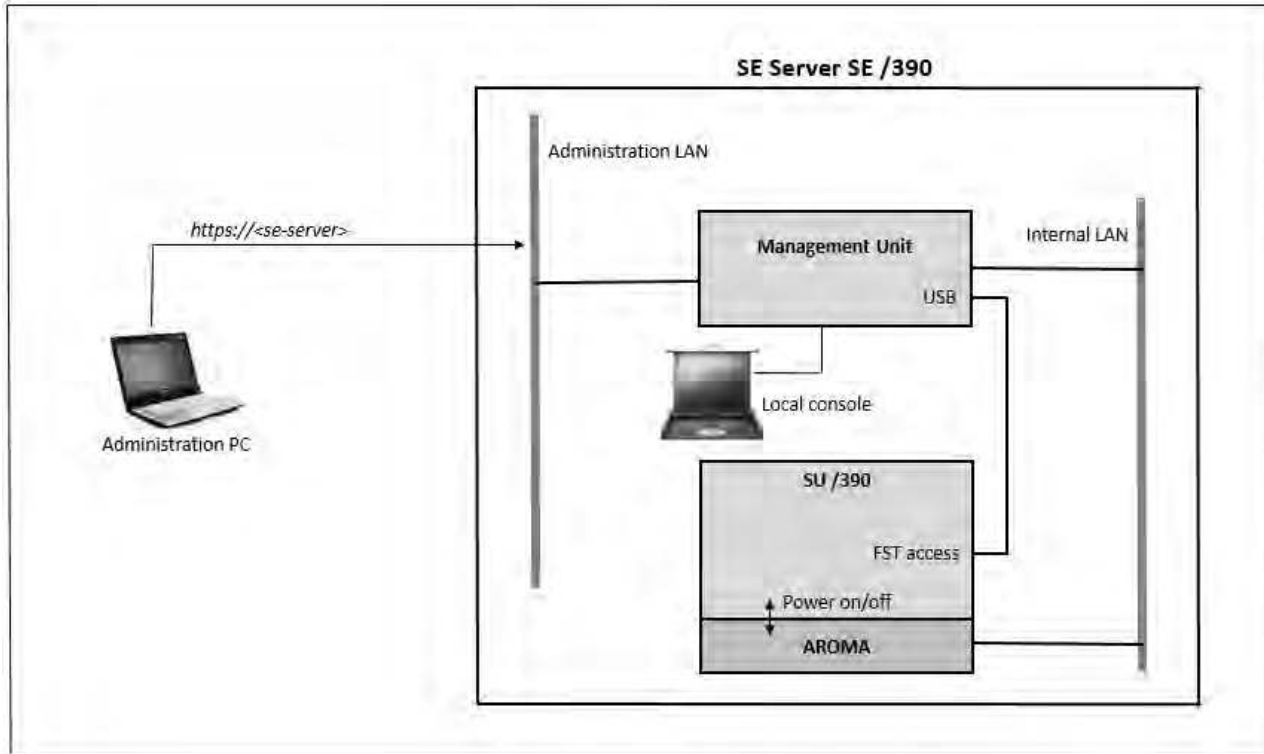

Figure 27: Hardware involved in switching the Server Unit /390 on/off

Detailed information on switching the hardware on/off using the SE Manager is provided in the "Operation and Administration" manual [5].

The following hardware components must be switched on in the specified order.

1. Switch on the optional hardware components

- > Switch on the ETERNUS LT140 tape library using the On/Off switch at the front (see the "Additive Components" Operating Manual [4]).
- > Switch on any other connected hardware components.

2. Switch on the MU

The power-on indicator (item 7 in figure 9 resp. item 2 in figure 11) lights up orange (POWER STAND-BY).

- > Switch on the rack console by pulling out and folding out the monitor, see "Rack console".
- > Press the On/Off switch on the MU (item 7 in figure 9 resp. item 2 in figure 11).

The power-on indicator lights up green. The MU switches itself on, conducts a system test and starts the M2000 software. This takes a little time. Finally, on the rack console you see the login window for the Linux desktop of the local console.

-
- > Call the SE Manager, e.g. after logging in on the local console via the browser of the Linux desktop (in the “Computer” menu in the task bar) or via an administration PC (standard way), see the “Operation and Administration” manual [5].

Redundant MUs are switched on in the same way.

You can also switch on the MU remotely via the iRMC of the MU, see the “Operation and Administration” manual [5].

3. Switch on the Server Unit SU /390

- > As administrator, BS2000 administrator or authorized BS2000 operator, switch on the Server Unit using the SE Manager (menu *Hardware* -> *Units*, *Units* tab, *Power on* icon), see the “Operation and Administration” manual [5].

Alternatively you can switch the Server Unit on by pressing the POWER ON button on the server's control panel (see "[Control panel \(on the SE /390\)](#)"). The system is ready when the status indicator on the server's control panel displays no further error codes.

Then you can call an SVP console window in the SE Manager and start the BS2000 system using PROGRAM LOAD FRAME: DETAIL-1.

When a POWER ON IPL is configured, the BS2000 system is loaded automatically (using AUXILIARY FRAME: LOAD PRESET1).

Alternatively the IPL can also be initiated in the SE Manager (menu *Systems* -> [*<se server> (SE<model>)* ->] *<unit> (SU</390>)* -> *BS2000 operation mode*, see the “Operation and Administration” manual [5]).

i The control panel and SVP frames of the Server Unit are described in the "Server Unit /390" Operating Manual [2].

4. Switch on the optional Server Units x86 (SE730 / SE730B only)

Before the Server Unit is switched on, the status indicator lights up orange.

- > Switch on the Server Unit by pressing the On/Off switch.

The power-on indicator lights up green. The Server Unit switches on, conducts a system test and starts X2000.

If automatic IPL is configured for BS2000, the BS2000 system (Native or as a VM2000 monitor system) is also started with the configured settings.

i The controls and indicators of the Server Unit are described in the "Server Unit x86" Operating Manual [3].

Further Server Units x86 are switched on in the same way.

5. Switch on the optional Application Units

Before an Application Unit is switched on, the status indicator lights up orange (POWER STAND-BY).

- > As administrator or AU administrator, switch on the Application Unit using the SE Manager (*Hardware -> Units* menu, *Units* tab, *Power on* icon), see the "Operation and Administration" manual [5].

Alternatively, switch on the Application Unit by pressing the On/Off switch.

The power-on indicator lights up green. The Application Unit switches on, conducts a system test and starts the operating system.

i The controls, indicators and further on/off options for the AU are described in the "Additive Components" Operating Manual [4].

Further Application Units are switched on in the same way.

8.2.3 Switching the SE server off

Figure 26 shows the hardware involved in switching the Server Unit /390 on/off.

The following hardware components must be switched off in the specified order.

! CAUTION!

This does not disconnect the hardware components completely from the power source (POWER STAND-BY). To cut the entire system off from the power source, you must disconnect the power distribution units from the power source.
Notify Customer Support.

1. Switch off the optional Application Units

Before the Application Unit is switched off, the power-on indicator lights up green.

- > Terminate the customer applications and the operating system properly.

The Application Unit is switched off automatically and enters standby mode. The status indicator lights up orange. Check this before continuing.

i If the operating system does not automatically switch off the Application Unit, hold the On/Off switch down for at least four seconds.

Alternatively, as administrator or AU administrator you can switch the Application Unit off using the SE Manager (menu *Hardware -> Units, Units* tab, *Power off* icon), see the "Operation and Administration" manual [5].

i The controls, indicators and further on/off options for the AU are described in the "Additive Components" Operating Manual [4].

Further Application Units are switched off in the same way.

2. Switch off the Server Unit SU /390

- > First make sure that the Native BS2000 system resp. all BS2000 VMs and the monitor system is shut down properly.
- > As administrator, BS2000 administrator or authorized BS2000 operator, switch off the Server Unit using the SE Manager (menu *Hardware -> Units, Units* tab, *Power off* icon), see the "Operation and Administration" manual [5].

Before the Server Unit is switched off, the power-on indicator lights up green, and after it has been switched off, it lights up orange. Check this before continuing.

Alternatively you can switch the Server Unit off by pressing the STAND-BY button on the server's control panel (see "Control panel (on the SE /390)") or via the SVP console (menu item POWER STAND-BY in AUXILIARY FRAME: POWER STAND-BY/IMPL). The BS2000 system should already have been shut down.

i The control panel and SVP frames of the Server Unit are described in the "Server Unit /390" Operating Manual [2].

3. Switch off the optional Server Units x86 (SE730 only)

- > As administrator, BS2000 administrator or authorized BS2000 operator, switch off the Server Unit using the SE Manager (menu *Hardware* -> *Units*, *Units* tab, *Power off* icon), see the "Operation and Administration" manual [5].

When the Server Unit is switched off, the BS2000 system is shut down properly taking into account the remaining runtime specified.

Before the Server Unit is switched off, the power-on indicator lights up green, and after it has been switched off, it lights up orange. Check this before continuing.

i The controls and indicators of the Server Unit are described in the "Server Unit x86" Operating Manual [3].

Further Server Units x86 are switched off in the same way.

4. Switch off the MU

- > Switch off the MU using the SE Manager (menu *Hardware* -> *Units*, *Units* tab, *Power off* icon), see the "Operation and Administration" manual [5]

Before the MU is switched off, the power-on indicator lights up green, and after it has been switched off, it lights up orange (item 7 resp. 2 in [figure 9/11](#)). Check this before continuing.

Redundant MUs are switched off in the same way.

5. Switch off the optional hardware components

- > Switch off the ETERNUS LT140 tape library using the On/Off switch on the front (see the "Additive Components" Operating Manual [4]).
- > Switch off any other connected hardware components.

9 Environmental protection and service

The Fujitsu servers have a long life expectancy, not only because of the excellent expansion options they offer, but also because of the quality of the products.

As technology continues to develop, however, ever greater volumes of data will need to be processed. More and more demands are being placed on storage capacity, speed and computer system design. So when you eventually want to replace your server with a newer model and dispose of the old device, we can also offer you support in this area.

Recycling old computer equipment is already a tradition at Fujitsu: We have been redeeming and reusing old computer systems for many years now. Even at the design stage, particular emphasis is placed on the reusability of components and materials.

Your server is manufactured to the greatest possible extent from environmentally friendly materials that can be fully recycled.

Read on through the next sections for a brief look at some of the measures we have introduced in an effort to protect the environment as well as our tips and suggestions for environmentally friendly handling of your system.

Environmentally friendly product design and development

This product has been designed in accordance with the guideline “environmentally friendly product design and development” of Fujitsu.

This means that the designers have taken into account critical factors such as durability, selection of materials and coding, emissions, packaging, the ease with which the product can be dismantled and the extent to which it can be recycled.

This saves resources and thus reduces the harm done to the environment.

Note on saving energy

If your device does not have to remain switched on permanently, only switch it on when you are ready to use it and then switch it off again during long breaks and when you finish your work.

Note on dealing with consumables

Please dispose of printer consumables and batteries in accordance with local government regulations.

Note on labeling plastic housing parts

Please avoid sticking your own labels on plastic housing parts wherever possible, since this makes it difficult to recycle them.

Take-back, recycling and disposal

Servers which are no longer required should first be used for other purposes before disposal or recycling is considered.

Fujitsu is a pioneer in matters of environmentally friendly computers and has been certified as providing environmental management in accordance with DIN EN ISO 14001. This also includes taking back your server and remarketing it or recycling it in an environmentally friendly manner.

To return your used server to Fujitsu, please contact

-
- your sales representative or
 - a branch of Fujitsu.

An offer will be submitted to you here or your server will be recycled free of charge at our remarketing and recycling center.

Service

If you have any complaints in relation to missing parts or incomplete delivery, please contact the Fujitsu complaints department:

Email: RLC@ts.fujitsu.com

Tel.: +49 (0) 3634 / 330 - 1758

Fax: +49 (0) 3634 / 330 - 1814

If you have questions on operation or if problems occur, please contact your local Fujitsu Customer Support, in Germany under:

Tel.: +49 (0) 89 3564 80 000

You can find all service numbers on the Fujitsu support pages:

<https://support.ts.fujitsu.com/IndexContact.asp?OpenTab=servicedesk>

10 Abbreviations

APCS	Automatic Power Control System
AROMA-P	Automatic and Remote Operation Manager
AU	Application Unit
CD	Compact Disk
DVD	Digital Versatile Disk
DVD-RW	Digital Versatile Disk - Read and Write
ECC	Error Correcting Code
EDC	Error Detection Code
ESD	Electrostatically Sensitive Device
FC	Fibre Channel
HBA	Host Bus Adapter
HDD	Hard Disk Drive
HNC	High-speed Net Connect
HU	Height Unit
ID	IDentifier
iRMC	Integrated Remote Management Controller
ISDN	Integrated Services Digital Network
IP	Internet Protocol
IT	Information Technology
LAN	Local Area Network
LCD	Liquid Crystal Display
LED	Light Emitting Diode
LTO	Linear Tape Open
NMI	Non Maskable Interrupt
MU	Management Unit
OCP	Operator Control Panel
PCI	Peripheral Component Interconnect
PDU	Power Distribution Unit
QSFP	Quad Small Form-factor Pluggable
RAID	Redundant Array of Disks
RMU	Remote Management Unit
RH	Relative Humidity
SAN	Storage Area Network
SAS	Serial Attach SCSI
SCSI	Small Computer System Interface
SU	Server Unit
SU /390	Server Unit /390
SU x86	Server Unit x86
USB	Universal Serial Bus
UPS	Uninterruptible Power Supply

11 Related publications

You can find the following BS2000 manuals on the manual server with the BS2000 documentation at <https://bs2manuals.ts.fujitsu.com>.

Other manuals, for example descriptions of the Fujitsu PRIMERGY and PRIMEQUEST servers, can be found on the general Fujitsu support pages at <https://support.ts.fujitsu.com/>.

- [1] **Fujitsu Server BS2000 SE Series
Basic Operating Manual**
- [2] **Fujitsu Server BS2000 SE Series
Server Unit /390
Operating Manual**
- [3] **Fujitsu Server BS2000 SE Series
Server Unit x86
Operating Manual**
- [4] **Fujitsu Server BS2000 SE Series
Additive Components
Operating Manual**
- [5] **Fujitsu Server BS2000 SE Series
Operation and Administration
User Guide**
- [6] **Fujitsu Server BS2000 SE Series
Security Manual
User Guide**
- [7] **Fujitsu Server BS2000 SE Series
Quick Guide
User Guide**
- [8] **Fujitsu Server BS2000 SE Series
Cluster Solutions for SE Servers
Whitepaper**